

## Operating Instructions

### DVD Recorder

Model No. **DMR-ES35V**

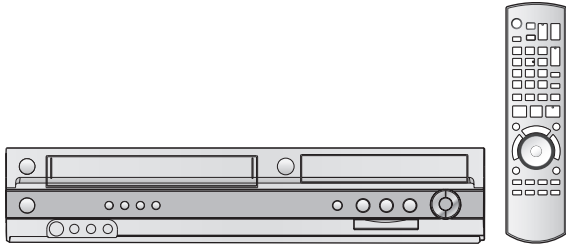

For Australia and New Zealand

**G-CODE®**

#### Region number supported by this unit

Region numbers are allocated to DVD players and DVD-Video according to where they are sold.

##### For Asia

- The region number of this unit is "3".
- The unit will play DVD-Video marked with labels containing "3" or "ALL".

Example:



##### For Australia and New Zealand

- The region number of this unit is "4".
- The unit will play DVD-Video marked with labels containing "4" or "ALL".

Example:



##### For the Middle East

- The region number of this unit is "2".
- The unit will play DVD-Video marked with labels containing "2" or "ALL".

Example:



# DIGA

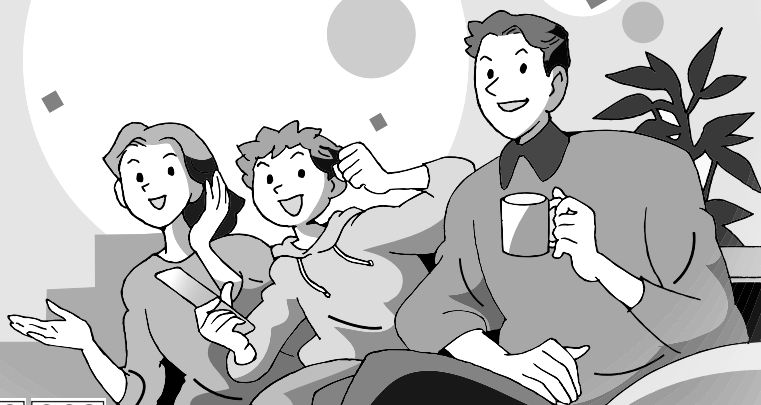

GN GC GCS

#### Dear customer

Thank you for purchasing this product. For optimum performance and safety, please read these instructions carefully.

Before connecting, operating or adjusting this product, please read the instructions completely. Please keep this manual for future reference.

Getting started

Recording

Playback

Editing

Transferring (Copying)

Convenient functions

Reference

# IMPORTANT SAFETY INSTRUCTIONS

## CAUTION!

THIS PRODUCT UTILIZES A LASER.  
USE OF CONTROLS OR ADJUSTMENTS OR PERFORMANCE OF PROCEDURES OTHER THAN THOSE SPECIFIED HEREIN MAY RESULT IN HAZARDOUS RADIATION EXPOSURE.  
DO NOT OPEN COVERS AND DO NOT REPAIR YOURSELF.  
REFER SERVICING TO QUALIFIED PERSONNEL.

## WARNING:

TO REDUCE THE RISK OF FIRE, ELECTRIC SHOCK OR PRODUCT DAMAGE, DO NOT EXPOSE THIS APPARATUS TO RAIN, MOISTURE, DRIPPING OR SPLASHING AND THAT NO OBJECTS FILLED WITH LIQUIDS, SUCH AS VASES, SHALL BE PLACED ON THE APPARATUS.

## CAUTION!

- DO NOT INSTALL OR PLACE THIS UNIT IN A BOOKCASE, BUILT-IN CABINET OR IN ANOTHER CONFINED SPACE. ENSURE THE UNIT IS WELL VENTILATED. TO PREVENT RISK OF ELECTRIC SHOCK OR FIRE HAZARD DUE TO OVERHEATING, ENSURE THAT CURTAINS AND ANY OTHER MATERIALS DO NOT OBSTRUCT THE VENTILATION VENTS.
- DO NOT OBSTRUCT THE UNIT'S VENTILATION OPENINGS WITH NEWSPAPERS, TABLECLOTHS, CURTAINS, AND SIMILAR ITEMS.
- DO NOT PLACE SOURCES OF NAKED FLAMES, SUCH AS LIGHTED CANDLES, ON THE UNIT.
- DISPOSE OF BATTERIES IN AN ENVIRONMENTALLY FRIENDLY MANNER.

### For Australia and New Zealand

THIS UNIT IS INTENDED FOR USE IN MODERATE CLIMATES.

### For Asia and the Middle East

THIS UNIT IS INTENDED FOR USE IN TROPICAL CLIMATES.

This product may receive radio interference caused by mobile telephones during use. If such interference is apparent, please increase separation between the product and the mobile telephone.

The socket outlet shall be installed near the equipment and easily accessible or the mains plug or an appliance coupler shall remain readily operable.

**CLASS 1  
LASER PRODUCT**



<b>DANGER - VISIBLE AND INVISIBLE LASER RADIATION WHEN OPEN. AVOID DIRECT EXPOSURE TO BEAM.</b> FDA 21 CFR Class IIIb	
注意	— 打开时有可见及不可见激光辐射。避免光束照射。
注意	— ここを開くと可視及び不可視レーザー光が出ます。ビームを見たり、触れたりしないでください。
<b>CAUTION - CLASS 3B VISIBLE AND INVISIBLE LASER RADIATION WHEN OPEN. AVOID EXPOSURE TO THE BEAM.</b> IEC60825-1:42/Class 3B	
<b>ATTENTION - RAYONNEMENT LASER VISIBLE ET INVISIBLE. CLASSE 3B. EN CAS D'OUVERTURE, EVITER UNE EXPOSITION AU FAISCEAU.</b>	
<b>FORSIGTIG - SYNLIG OG USYNLIG LASERSTRÅLING KLASSE 3B. NÅR LÅGET ER ÅBENT, UNDGÅ AT BLIVE UDSAT FOR STRÅLEN.</b>	
<b>VARO - AVATTAESSA OLET ALTIINA LUKKAN 3B NÄKYVÄÄ JA NÄKYMÄTÖNTÄ LASERSÄTELYÄ, VÄRÖ ALTIISTUMISTA SÄTEELLE.</b>	
<b>WARNING - KLASS 3B SYNLIG OCH USYNLIG LASERSTRÅLNING NÄR DENNA DEL ÄR ÖPPNAD, UNDVÄK EXPONERING FÖR STRÅLEN.</b>	
<b>VORSICHT - SICHTBARE UND UNSICHTBARE LASERSTRÄHLUNG KLASSE 3B. WENN ABDECKUNG GEÖFFNET, NICHT DEM STRAHL AUSSETZEN.</b>	
<b>CAUTION - VISIBLE AND INVISIBLE LASER RADIATION WHEN OPEN. AVOID EXPOSURE TO THE BEAM.</b> IEC60825-1	
<b>ATTENTION - RAYONNEMENT LASER VISIBLE ET INVISIBLE EN CAS D'OUVERTURE. EXPOSITION DANGEREUSE AU FAISCEAU.</b>	
<b>ADVARSEL - SYNLIG OG USYNLIG LASERSTRÅLING VED ÅBNING. UNDGÅ UDSÆTTELSE FOR STRÅLING.</b>	
<b>VARO! - AVATTAESSA OLET ALTIINA NÄKYVÄÄ JA NÄKYMÄTÖN LASERSÄTELYLLE, ÄLÄ KATSO SÄTEESEEN.</b>	
<b>WARNING - SYNLIG OCH OSYNLIG LASERSTRÅLNING NÄR DENNA DEL ÄR ÖPPNAD, BETRÄKTA EJ STRÅLEN.</b>	
<b>VORSICHT - SICHTBARE UND UNSICHTBARE LASERSTRÄHLUNG, WENN ABDECKUNG GEÖFFNET, NICHT DEM STRAHL AUSSETZEN.</b>	
<b>ADVARSEL - SYNLIG OG USYNLIG LASERSTRÅLING NÄR DEKSEL ÅPNES, UNNGÅ EKSPONERING FÖR STRÅLEN.</b> RQV050003	

(Inside of product)

## Caution for AC Mains Lead (For Saudi Arabia)

For your safety, please read the following text carefully.

This appliance is supplied with a moulded three pin mains plug for your safety and convenience.

A 5-ampere fuse is fitted in this plug.

Should the fuse need to be replaced please ensure that the replacement fuse has a rating of 5-ampere and that it is approved by ASTA or BSI to BS1362.

Check for the ASTA mark  or the BSI mark  on the body of the fuse.

If the plug contains a removable fuse cover you must ensure that it is refitted when the fuse is replaced.

If you lose the fuse cover the plug must not be used until a replacement cover is obtained.

A replacement fuse cover can be purchased from your local dealer.

## CAUTION!

**IF THE FITTED MOULDED PLUG IS UNSUITABLE FOR THE SOCKET OUTLET IN YOUR HOME THEN THE FUSE SHOULD BE REMOVED AND THE PLUG CUT OFF AND DISPOSED OF SAFELY. THERE IS A DANGER OF SEVERE ELECTRICAL SHOCK IF THE CUT OFF PLUG IS INSERTED INTO ANY 13- AMPERE SOCKET.**

If a new plug is to be fitted please observe the wiring code as stated below.

If in any doubt please consult a qualified electrician.

## IMPORTANT

The wires in this mains lead are coloured in accordance with the following code:

Blue: Neutral, Brown: Live.

As these colours may not correspond with the coloured markings identifying the terminals in your plug, proceed as follows:

The wire which is coloured Blue must be connected to the terminal which is marked with the letter N or coloured Black or Blue.

The wire which is coloured Brown must be connected to the terminal which is marked with the letter L or coloured Brown or Red.

**WARNING: DO NOT CONNECT EITHER WIRE TO THE EARTH TERMINAL WHICH IS MARKED WITH THE LETTER E, BY THE EARTH SYMBOL  $\perp$  OR COLOURED GREEN OR GREEN/YELLOW.**

**THIS PLUG IS NOT WATERPROOF—KEEP DRY.**

## Before use

Remove the connector cover.

## How to replace the fuse

The location of the fuse differ according to the type of AC mains plug (figures A and B). Confirm the AC mains plug fitted and follow the instructions below.

Illustrations may differ from actual AC mains plug.

1. Open the fuse cover with a screwdriver.

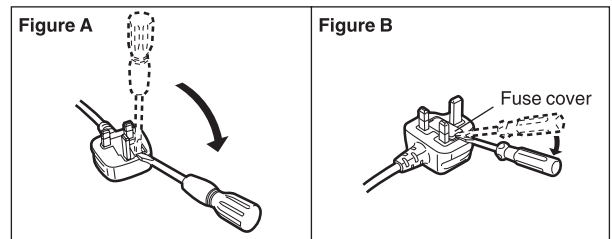

2. Replace the fuse and close or attach the fuse cover.

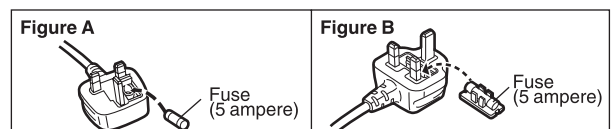

# Precautions

## Do not place the unit on amplifiers or equipment that may become hot.

The heat can damage the unit.



## Before moving the unit, ensure the disc tray is empty. Failure to do so will risk severely damaging the disc and the unit.

### ■ Precautions for installation

- The unit should not be installed or operated near large magnets or electromagnetic devices. Such devices can damage pre-recorded VHS recordings.
- Do not place any heavy objects atop the unit and do not install it in a confined space. Please allow for adequate air circulation.
- The unit should not be mounted in a vertical position. It is designed to operate in the horizontal position.

### ■ Important

Your attention is drawn to the fact that the recording of pre-recorded video cassettes or discs or other published or broadcast material may infringe copyright laws.

### ■ For your safety

Do not remove outer cover.

Touching internal parts of the unit is dangerous and may seriously damage it.

To prevent electric shock, do not remove cover. There are no user serviceable parts inside. Refer all servicing to qualified service personnel.

### ■ Conserve the environment

See "Power Save" of page 59.

### ■ Cautions before you operate this unit

Avoid:

- Humidity and dust.
- Extreme heat such as direct sunlight.
- Magnets or electromagnetic objects.
- Touching internal parts of the unit.
- Water or some other liquid.
- Lightning. (Disconnect the aerial plug from the unit during lightning storms.)
- Anything heavy on the unit.
- Connecting or handling the equipment with wet hands.
- Using a cell phone near the unit because it may cause noise affecting the picture and sound.

Do:

- Wipe the unit with a clean and dry cloth.
- Install the unit in a horizontal position.
- Keep the unit, TV and other equipment switched off until all connections are finished.

### ■ Notes on these instructions

- Company names, product names and all other names in these instructions are the trademarks or registered trademarks of their respective corporations.
- These operating instructions describe operations mainly using the remote control.
- The contents of the screens used in these instructions may not necessarily match what you will see on your screen.

### ■ Displays

The displays shown in these instructions are examples. Actual displays depend on discs.

- In certain circumstances, icons will be displayed in grey and will not respond if clicked on. This means that the function represented by the icon is disabled.

## About descriptions in these operating instructions

- Pages to be referred to are indicated as (→ ○○).

## Useful features

You can enjoy both DVD and VHS with the unit.

This DVD Recorder can record images and sounds in high quality to rapid random access capable DVD media. This has resulted in many new features that outperform older video cassette formats. The following information summarizes a few of these features.

### ■ DVD

#### Progressive output (→ 13, 16)

If you connect the unit with a progressive output-compatible TV, you can enjoy higher-quality and less-flicker images than conventional TVs (of the interlace output type) can present.

#### Finalize (→ 56)

This function enables you to play recorded DVD-R, DVD-R DL, DVD-RW, +R and +R DL on other players.

#### Instant play (→ 26)

There is no need to rewind or search forward. Direct Navigator guides you to the beginning of a previously recorded video immediately.

#### Quick view (→ 26)

This function allows you to watch news, information and other programmes in a short time.

#### Chasing play (→ 21)

There is no need to wait until recording is complete. Without stopping recording, you can play the video currently being recorded from its beginning.

#### Instant recording (→ 18)

You no longer need to search for empty disc space. By pressing the recording button, the unit finds available recording space and begins recording right away.

#### Simultaneous rec and play (→ 21)

With this function, you can play a previously recorded video programme while recording another programme.

#### Time slip (→ 27)

This function enables you to jump to the scene you specify during play.

### ■ Common

#### One Touch Transfer (Copying) (→ 45, 47)

This function can copy video from VHS to DVD and vice versa.

## -If you see this symbol-

### Information on Disposal in other Countries outside the European Union



This symbol is only valid in the European Union.

If you wish to discard this product, please contact your local authorities or dealer and ask for the correct method of disposal.

## Getting started

<b>IMPORTANT SAFETY INSTRUCTIONS</b> .....	<b>2</b>
<b>Precautions</b> .....	<b>3</b>
<b>About descriptions in these operating instructions</b> .....	<b>3</b>
<b>Useful features</b> .....	<b>3</b>
<b>Accessories</b> .....	<b>5</b>
<b>Disc information</b> .....	<b>6</b>
Discs you can use for recording and play [12 cm/8 cm].....	6
Play-only discs [12 cm/8 cm].....	7
Regarding recording formats.....	7
Discs that cannot be played.....	7
Concerning logo marks.....	7
Which Disc Types is Playable on What TV.....	8
Disc handling.....	8
<b>Maintenance</b> .....	<b>8</b>
<b>Using DVD-R, DVD-R DL, DVD-RW, +R, +R DL and +RW on this unit</b> .....	<b>9</b>
<b>Control reference guide</b> .....	<b>10</b>
<b>Remote control</b> .....	<b>10</b>
<b>Main unit</b> .....	<b>11</b>
The unit's display.....	11
<b>STEP 1 Connection</b> .....	<b>12</b>
Connecting a TV.....	12
Connecting an amplifier or system component.....	13
• Connecting an amplifier with a digital input terminal.....	13
• Connection to an analogue stereo amplifier.....	13
DVD output and DVD/VHS output.....	13
To enjoy even higher fidelity.....	13
• Connection to the TV's S Video terminal.....	13
• Connection to the TV's component video terminals.....	13
<b>STEP 2 Auto-Setup</b> .....	<b>14</b>
Auto-Setup.....	14
<b>STEP 3 Set up to match your TV and remote control</b> .....	<b>15</b>
When other Panasonic products respond to this remote control.....	15
Selecting the television type.....	15
Television operation.....	15
To enjoy progressive video.....	16
• Note to owners of progressive compatible PAL system televisions.....	16

## Recording

<b>Recording television programmes</b> .....	<b>17</b>
Inserting a disc.....	17
Inserting a video cassette.....	17
Recording procedures.....	18
• Recording modes and approximate recording times.....	19
• When the format confirmation screen is displayed.....	20
• When removing a recorded disc.....	20
Specifying the time when recording will stop.....	21
Select audio to record.....	21
Playing DVD while recording VHS.....	21
Playing VHS while recording DVD.....	21
Watching the TV while recording.....	21
Playing while you are recording.....	21
• Playing from the beginning of the title you are recording— Chasing play.....	21
• Play a title previously recorded while recording— Simultaneous rec and play.....	21
Flexible Recording mode (FR).....	22
<b>Timer Recording</b> .....	<b>23</b>
Cautions for using timer recording.....	23
Timer Recording.....	23
Using G-CODE system.....	23
Manual programming.....	24
• Check, change or delete programmes.....	25
• Cancel a timer recording that has already begun.....	25
• Release programme from standby.....	25
• Auto SP/LP mode.....	25

## Playback

<b>Playing discs</b> .....	<b>26</b>
Playing discs.....	26
• When a menu screen appears on the TV.....	26
Selecting recorded titles to play.....	26
Quick View (Play X1.3).....	26
Manual Skip.....	26
Fast forward and rewind — SEARCH.....	27
Skipping.....	27
Slow-motion play.....	27
Frame-by-frame viewing.....	27
Direct play.....	27
Deleting a title that is being played.....	27
Select an amount of time to skip — Time Slip.....	27
Create chapters.....	27
Changing audio during play.....	27
<b>Using menus to play DivX, MP3 and still pictures (JPEG/TIFF)</b> .....	<b>28</b>
Playing discs which contain DivX video contents, MP3 and still pictures.....	28
To select the file type.....	28
Playing DivX video contents.....	28
• Using the tree screen to find a folder.....	28
About DivX VOD content.....	29
Playing MP3.....	29
• Using the tree screen to find a group.....	29
Playing a still picture.....	30
• Start Slide Show/Slide Interval.....	30
• To select still pictures in another folder.....	30
<b>Playing a video cassette</b> .....	<b>32</b>
Fast-forward/Rewind.....	32
Cue/Review.....	32
Jet Search.....	32
Slow-motion play.....	32
Jet Rewind.....	32
S-VHS Quasi Playback (SQPB).....	32
Repeat Playback.....	32
Adjusting the playback picture.....	33
• Manual tracking.....	33
• Vertical locking adjustment.....	33
VHS Index Search System (VISS).....	33
Changing audio during play.....	33
Various indications in on-screen display.....	33
<b>Using on-screen menus/FUNCTIONS window</b> .....	<b>34</b>
Using DISPLAY menus.....	34
• Common procedures.....	34
- Disc menu.....	34
- Play menu.....	35
- Picture menu.....	35
- Sound menu.....	35
- Other menu.....	35
<b>Status messages</b> .....	<b>36</b>
FUNCTIONS window.....	36
Status displays.....	36
• Changing the information displayed.....	36
• Display examples.....	36
<b>Child Lock</b> .....	<b>36</b>
<b>Editing</b> .....	<b>37</b>
<b>Edit titles</b> .....	<b>37</b>
Editing titles with SUB MENU button.....	37
Title operations.....	37
• Delete.....	37
• Properties.....	37
• Edit.....	38
- Enter Name.....	38
- Set up Protection/Cancel Protection.....	38
- Partial Delete.....	38
- Change Thumbnail.....	38
- Divide Title.....	39
<b>Edit Chapters</b> .....	<b>39</b>
Chapter operations.....	39
• Chapter View.....	39
- Delete Chapter.....	39
- Create Chapter.....	39
- Combine Chapters.....	39
- Title View.....	39

## Editing

<b>Creating, editing and playing playlists</b> .....	<b>40</b>
Creating playlists .....	40
Playing playlists .....	41
Editing playlists with SUB MENU button .....	41
Playlist operations .....	41
• Delete .....	41
• Properties .....	41
• Edit.....	42
- Create .....	42
- Copy.....	42
- Enter Name.....	42
- Change Thumbnail.....	42
Chapter operations.....	43
• Chapter View .....	43
- Add Chapter.....	43
- Move Chapter .....	43
- Create Chapter .....	43
- Combine Chapters .....	43
- Delete Chapter.....	43
- Playlist View.....	43

## Transferring (Copying)

<b>Transfer (Copying)</b> .....	<b>44</b>
Before transferring (copying) .....	44
Transfer (Copying) from VHS .....	45
• One Touch Transfer (copying) (VHS → DVD) .....	45
• GUI (Graphical User Interface)	
Transfer (Copying) (VHS → DVD) .....	46
Transfer (Copying) from DVD .....	47
• One Touch Transfer (copying) (DVD → VHS) .....	47
• GUI (Graphical User Interface)	
Transfer (copying) (DVD → VHS) .....	48
Transfer (copying) a finalized DVD-R, DVD-R DL,	
DVD-RW (DVD-Video format), +R, +R DL or DVD-Video .....	49
Recording from an external device.....	50
• DVD .....	50
• VHS .....	50
DV automatic recording .....	51

## Convenient functions

<b>Entering text</b> .....	<b>52</b>
Entering text .....	52
<b>Deleting titles</b> .....	<b>53</b>
Delete Navigator.....	53
Deleting a title during play .....	53
<b>DVD Management</b> .....	<b>54</b>
Disc Name.....	54
Disc Protection .....	55
Delete all titles.....	55
Auto-Play Select.....	55
Create Top Menu .....	55
Format Disc.....	55
Finalize .....	56
Close First Layer .....	56
<b>Changing the unit's settings</b> .....	<b>57</b>
Common procedures.....	57
Entering a password (Ratings).....	57
Summary of settings.....	57
<b>Resetting the channel setting</b> .....	<b>60</b>
Tuning .....	60
• Manual.....	60
• To change detailed station settings.....	60
• Automatic setting .....	61
<b>Set the clock manually</b> .....	<b>61</b>

## Reference

<b>Glossary</b> .....	<b>62</b>
<b>Error messages</b> .....	<b>63</b>
<b>Frequently asked questions</b> .....	<b>65</b>
<b>Troubleshooting guide</b> .....	<b>66</b>
<b>Specifications</b> .....	<b>71</b>
<b>Index</b> .....	<b>73</b>

## Accessories

 Please check and identify the supplied accessories. Use the numbers indicated in the brackets when asking for replacements. (Product numbers correct as of April 2006. These may be subject to change.)

**For Asia**  
 1 AC mains lead



**For Australia and New Zealand**  
 1 AC mains lead



**For the Middle East**  
 2 AC mains leads



**For Saudi Arabia**

1 RF coaxial cable



1 Audio/Video cable



2 Batteries for the remote control  
 R6 size

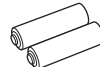

**For Asia**  
 1 Remote control  
 (EUR7659YL0)



**For Australia and New Zealand**  
 1 Remote control  
 (EUR7659YJ0)







**For the Middle East**  
 1 Remote control  
 (EUR7659YL0)



• For use with the unit only. Do not use it with other equipment. Also, do not use cords belonging to other equipment with the unit.

# Disc information

## Discs you can use for recording and play [12 cm/8 cm]

Disc type	DVD-RAM ● 4.7 GB/9.4 GB, 12 cm ● 2.8 GB, 8 cm	DVD-R ● 4.7 GB, 12 cm ● 1.4 GB, 8 cm	DVD-R DL <sup>*1</sup> (dual layer on single side) ● 8.5 GB, 12 cm	DVD-RW ● 4.7 GB, 12 cm ● 1.4 GB, 8 cm	+R <sup>*2</sup> ● 4.7 GB, 12 cm	+R DL <sup>*1</sup> (double layer on single side) ● 8.5 GB, 12 cm	+RW ● 4.7 GB, 12 cm
Logo					—	—	—
Indicated in these instructions with	<b>RAM</b>	<b>-R</b> before finalization <b>DVD-V</b> after finalization	<b>-R DL</b> before finalization <b>DVD-V</b> after finalization	<b>-RW(V)</b> before finalization <b>DVD-V</b> after finalization	<b>+R</b> before finalization <b>DVD-V</b> after finalization	<b>+R DL</b> before finalization <b>DVD-V</b> after finalization	<b>+RW</b>
Recording format	DVD Video Recording format	DVD-Video format			+VR format		
Main use <sup>*3</sup>	Re-writable discs	One time recording discs (recordable until the disc is full)	One time recording discs (recordable until the disc is full)	Re-writable discs	One time recording discs (recordable until the disc is full)	One time recording discs (recordable until the disc is full)	Re-writable discs
<b>Compatibility</b>							
Usable high speed recording disc <sup>*4</sup>	Up to 5x	Up to 16x	Up to 4x	Up to 6x	Up to 16x	Up to 2.4x	Up to 4x <sup>*5</sup>
Play on other player	Only on DVD-RAM compatible players. (It is not possible to finalize the disc.)	Only after finalizing the disc. (→ 56, 62)	Only after finalizing the disc <sup>*6</sup> . (→ 56, 62)	Only after finalizing the disc. (→ 56, 62)	Only after finalizing the disc. (→ 56, 62)	Only after finalizing the disc. (→ 56, 62)	Yes. (It is not possible to finalize the disc.)
<b>What you can do on this unit (✓: Possible, ✗: Impossible)</b>							
Chasing playback	✓	✗	✗	✗	✗	✗	✗
Recording broadcasts that allow one copy	✓ <sup>*7</sup>	✗	✗	✗	✗	✗	✗
Recording both M 1 and M 2 of bilingual broadcast	✓	✗ Only one is recorded. (→ 58, Bilingual Audio Selection)	✗ Only one is recorded. (→ 58, Bilingual Audio Selection)	✗ Only one is recorded. (→ 58, Bilingual Audio Selection)	✗ Only one is recorded. (→ 58, Bilingual Audio Selection)	✗ Only one is recorded. (→ 58, Bilingual Audio Selection)	✗ Only one is recorded. (→ 58, Bilingual Audio Selection)
Recording 16:9 aspect picture	✓	✗ (The picture is recorded in 4:3 aspect.)	✗ (The picture is recorded in 4:3 aspect.)	✗ (The picture is recorded in 4:3 aspect.)	✗ (The picture is recorded in 4:3 aspect.)	✗ (The picture is recorded in 4:3 aspect.)	✗ (The picture is recorded in 4:3 aspect.)
Entering text	✓	✓	✓	✓	✓	✓	✓
Deleting titles	✓	✓ (Available space does not increase after deleting.)	✓ (Available space does not increase after deleting.)	✓ (Disc space increases only when the title recorded last is deleted.)	✓ (Available space does not increase after deleting.)	✓ (Available space does not increase after deleting.)	✓ (Disc space increases only when the title recorded last is deleted.)
Creating playlists	✓	✗	✗	✗	✗	✗	✗

\*1 You can record onto the second layer of dual- or double-layer discs after closing the first layer. However you will no longer be able to record to the first layer (→ 56).

\*2 You may not be able to use +R recorded on this unit in another Panasonic DVD recorder and vice versa. Once the disc is finalized, however, it can be played in the other unit.

\*3 The amount of the recordable disc space does not increase even if the programme is deleted when you use a one time recording disc.

\*4 This unit can use the high-speed recording discs shown in the chart, but using them will not shorten the recording time.

\*5 It is possible to play 8x recording speed discs recorded on other equipment.

\*6 Playable on DVD-R DL compatible equipment.

\*7 CPRM (→ 62) compatible discs only

● The explanations concerning discs are indicated by **DVD** and those concerning video cassettes are indicated by **VHS**.

● We recommend using Panasonic discs. We recommend using DVD-RAM discs with cartridges to protect them from scratches and dirt.

● Discs from other manufacturers may not be recorded or played due to the condition of the recording.

● You cannot record programmes that allow "One time only recording" to CPRM compatible DVD-R, DVD-R DL and DVD-RW on this unit. You can record other programmes in the DVD-Video format.

● You can use high speed recording compatible discs on this unit.

● This unit cannot record to discs containing both PAL and NTSC signals. Play of discs recorded with both PAL and NTSC on another unit is not guaranteed.

**The manufacturer accepts no responsibility and offers no compensation for loss of recorded or edited material due to a problem with the unit or recordable media, and accepts no responsibility and offers no compensation for any subsequent damage caused by such loss.**

**Examples of causes of such losses are**





● A disc recorded and edited with this unit is played in a DVD Recorder or computer disc drive manufactured by another company.

● A disc used as described above and then played again in this unit.

● A disc recorded and edited with a DVD Recorder or computer disc drive manufactured by another company is played in this unit.



## Play-only discs [12 cm/8 cm]

Disc type	DVD-Video	DVD-Audio	DVD-RW (DVD Video Recording format)	CD		Video CD
Logo					-	
Indicated in these instructions with	<b>DVD-V</b>	<b>DVD-A</b>	<b>-RW(VR)</b>	<b>CD</b>		<b>VCD</b>
Instructions	High quality movie and music discs	High fidelity music discs • Played on this unit in 2 channels	DVD-RW* recorded on another DVD Recorder • You can play programmes that allow "One time only recording" if they have been recorded to a CPRM compatible disc. • By formatting (→ 55) the disc, you can record to it in DVD-Video format and play it on the unit.  It may be necessary to finalize the disc on the equipment used for recording.	Recorded audio and music (including CD-R/RW*)	CD-R* and CD-RW* with DivX video contents, music recorded in MP3 and still pictures (JPEG and TIFF) (→ 28).	Recorded music and video (including CD-R/RW*)

\* Play may be impossible on some DVD-RW (DVD Video Recording format), CD-R or CD-RW discs due to the condition of the recording.

- You can play DivX video contents recorded on DVD-R and DivX video contents, still pictures (JPEG/TIFF), CD-DA, Video CD and MP3 format data recorded on CD-R/RW.

Close the session or finalize the disc after recording on the computer.

- The producer of the disc can control how discs are played. So you may not always be able to control play as described in these operating instructions. Read the disc's instructions carefully.

**Note about using a DualDisc**

The digital audio content side of a DualDisc does not meet the technical specifications of the Compact Disc Digital Audio (CD-DA) format so play may not be possible.

**Regarding DVD-Audio**

Some multi-channel DVD-Audio will prevent down-mixing (→ 62) of all or part of their contents if this is the manufacturer's intention. Tracks that are prevented from being down-mixed will not play properly on this unit (e.g., audio is played from the front two channels only). Refer to the disc's jacket for more information.

## Regarding recording formats

**■ DVD Video Recording format**

This is a recording method which allows you to record and edit TV broadcasts and so on.

- Digital broadcasts that allow "One time only recording" can be recorded to a CPRM compatible disc. You can record to CPRM compatible DVD-RAM on this unit.
- Play is only possible on a compatible DVD player.

**Use a DVD-RAM to record in DVD Video Recording format.**

**■ DVD-Video format**

This recording method is the same as commercially available DVD-Video.

- Digital broadcasts that allow "One time only recording" cannot be recorded.
- These can be played on a DVD player. However programmes recorded on this unit must be finalized to be played on other DVD players.

**Use a DVD-R, DVD-R DL or DVD-RW to record in DVD-Video format.**

**■ +VR (+R/+RW Video Recording) format**



This is a method for recording moving pictures to +R/+RW discs. You can play back discs recorded in this method in a similar way as contents recorded in the DVD-Video format.

- Digital broadcasts that allow "One time only recording" cannot be recorded.
- After finalizing the disc or creating the top menu, you can play the disc on DVD players and other equipment.

## Discs that cannot be played

- 2.6/5.2 GB DVD-RAM, 12 cm
- 3.95/4.7 GB DVD-R for Authoring
- DVD-R recorded in DVD Video Recording format
- DVD-R (DVD-Video format), DVD-R DL, DVD-RW (DVD-Video format), +R, +R DL recorded on another unit and not finalized (→ 62, Finalize)
- **For Asia**  
DVD-Video with a region number other than "3" or "ALL"
- **For Australia and New Zealand**  
DVD-Video with a region number other than "4" or "ALL"
- **For the Middle East**  
DVD-Video with a region number other than "2" or "ALL"
- Blu-ray, DVD-ROM, +R 8 cm, CD-ROM, CDV, CD-G, Photo CD, CVD, SVCD, SACD, MV-Disc, PD, etc.

## Concerning logo marks

	<b>Dolby Digital (→ 58)</b> This is a method of coding digital signals developed by Dolby Laboratories. Not only stereo (2 channel) audio, these signals can also be multi-channel audio. A large amount of audio information can be recorded on one disc by this method.
	<b>DTS Digital Surround (→ 58)</b> This surround system is used in many movie theatres around the world. The separation between channels is good and the compression ratio is low, so realistic sound effects are possible.

### Which Disc Types is Playable on What TV

When you use a discs recorded in either PAL or NTSC, refer to this table.

TV type	Disc	Playable* <sup>1</sup>
Multi-system TV	PAL	✓
	NTSC	✓* <sup>2</sup>
NTSC TV	PAL	×
	NTSC	✓* <sup>3</sup>
PAL TV	PAL	✓
	NTSC	✓* <sup>4</sup> (PAL 60)

\*1 Playable (✓: Possible, ×: Impossible)  
 \*2 If you select "NTSC" in "TV System" (→ 59), the picture may be clearer.  
 \*3 Select "NTSC" in "TV System" (→ 59).  
 \*4 If your TV is not equipped to handle PAL 525/60 signals the picture will not be displayed correctly.

#### Optional accessories

(Product numbers correct as of April 2006. These may be subject to change.)

##### DVD-RAM

- 9.4 GB, double-sided, cartridge type:  
LM-AD240LE (compatible with high speed recording 3X)
- 9.4 GB, double-sided, non-cartridge type:  
LM-AE240LE (Pro Hard Coating, compatible with high speed recording 3X)
- 4.7 GB, single-sided, cartridge type:  
LM-AB120LE (compatible with high speed recording 3X)
- 4.7 GB, single-sided, non-cartridge:  
LM-AE120LE (Pro Hard Coating, compatible with high speed recording 3X)  
LM-AF120LE (compatible with high speed recording 3X)

##### DVD-R

- 4.7 GB, single-sided, non-cartridge:  
LM-RF120ME (compatible with high speed recording 8X)

##### DVD-RW

- 4.7 GB, single-sided, non-cartridge:  
LM-RW120E (compatible with high speed recording 2X)

### Disc handling

#### How to hold a disc

Do not touch the recorded surface.



#### Concerning non-cartridge discs

Be careful about scratches and dirt.

#### If there is dirt or condensation on the disc

Wipe with a damp cloth and then wipe dry.



#### Handling precautions

- Do not attach labels or stickers to the discs. (This may cause disc warping and unbalanced rotation, rendering it unusable.)
- Write on the label side of the disc only with a soft, oil-based felt pen. Do not use ballpoint pens or other hard writing implements.
- Do not use record cleaning sprays, benzene, thinner, static electricity prevention liquids or any other solvent.
- Do not use scratch-proof protectors or covers.
- Do not drop, stack, or cause impact to discs. Do not place objects on them.
- Do not use the following discs:
  - Discs with exposed adhesive from removed stickers or labels (rental discs etc.).
  - Discs that are badly warped or cracked.
  - Irregularly shaped discs, such as heart shapes.

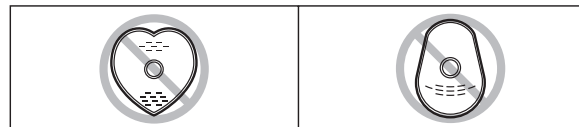

- Do not place in the following areas:
  - In direct sunlight.
  - In very dusty or humid areas.
  - Near a heater.
  - Locations susceptible to significant differences in temperature (condensation can occur).
  - Where static electricity or electromagnetic waves occur.
- To protect discs from scratches and dirt, return them to their cases or cartridges when you are not using them.

### Maintenance

The precision parts in the unit are readily affected by the environment, especially temperature, humidity and dust. Cigarette smoke can also cause malfunction or breakdown.

#### To clean the unit, wipe with a soft, dry cloth.

- Never use alcohol, paint thinner or benzene to clean the unit.
- Before using chemically treated cloth, carefully read the instructions that came with the cloth.

#### Observe the following points to ensure continued listening and viewing pleasure.

Dust and dirt may adhere to the unit's lens over time, making it impossible to record or play discs.

Use the **DVD lens cleaner** about once every year depending on the frequency of use and the operating environment.

Carefully read the lens cleaner's instructions before use.

DVD lens cleaner: RP-CL720E



## Restrictions with DVD-R, etc.\*

- 16:9 aspect programmes are recorded in 4:3 aspect.
- The main (M 1) or secondary audio (M 2) only can be recorded for bilingual broadcasts.
- Playing the disc on other DVD players is not possible before finalizing.

\* DVD-R, DVD-R DL, DVD-RW, +R, +R DL and +RW are collectively referred to as "DVD-R, etc." on this page.

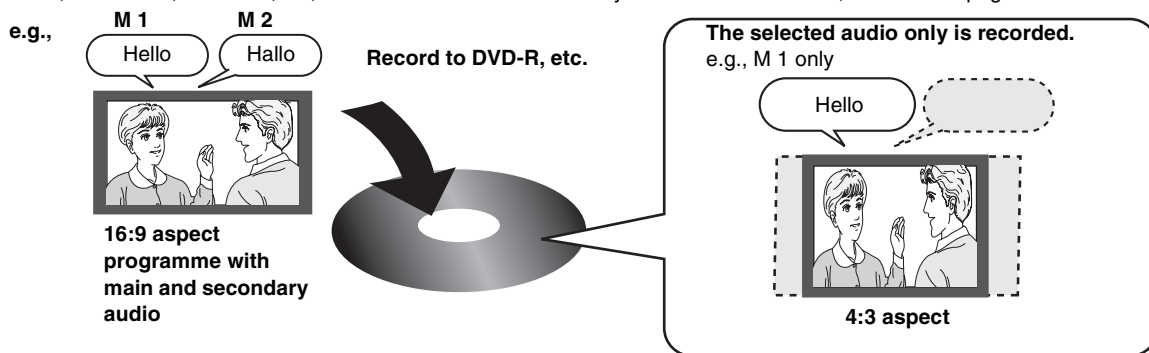

Therefore, follow the steps below when you use DVD-R, etc.

## When recording a bilingual programme to DVD-R, etc.

Select the audio to record before recording or transferring (copying).

Some television programmes are broadcast with main (M 1) and secondary audio (M 2). You have to select the audio recording type before recording or transferring (copying) them to DVD-R, etc.

- When recording from a TV tuner

Select "M 1" or "M 2" in "Bilingual Audio Selection" in the Setup menu (→ 58).

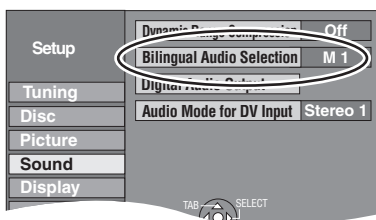
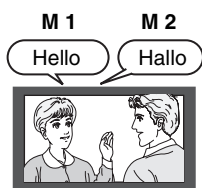

Record to DVD-R, etc. The selected audio only is recorded.

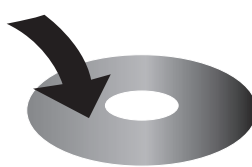

- When recording from the external equipment
  - Select M 1 or M 2 on the external equipment.

## Playing the disc on other DVD players

The disc must be finalized after recording or transferring (copying) (→ 56).

It is necessary to finalize DVD-R, etc. on this unit after recording or transferring (copying) titles to them. You can then play them as a commercially sold DVD-Video. However the discs become play-only and you can no longer record or transfer (copy).\*

\* You can record and transfer (copy) again if you format DVD-RW and +RW.

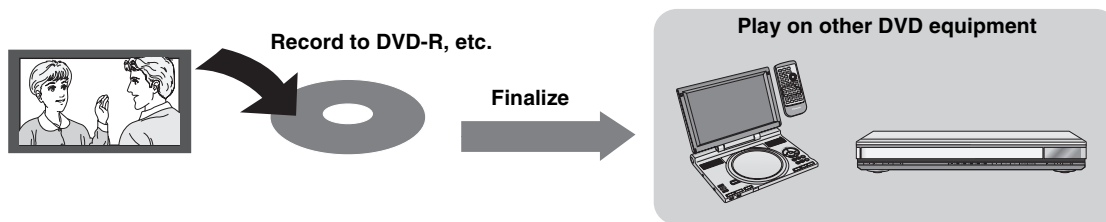

## Recording to a DVD-R DL and +R DL

DVD-R DL and +R DL discs have two layers of recordable surfaces on one side.

It is not possible to record continuously from the first layer to the second layer. Recording stops when the space on the first layer becomes full. You must close the first layer to start recording on the second layer. Closing makes the first layer unavailable for recording (editing is still available). You cannot cancel closing. Make certain before proceeding. (→ 56)

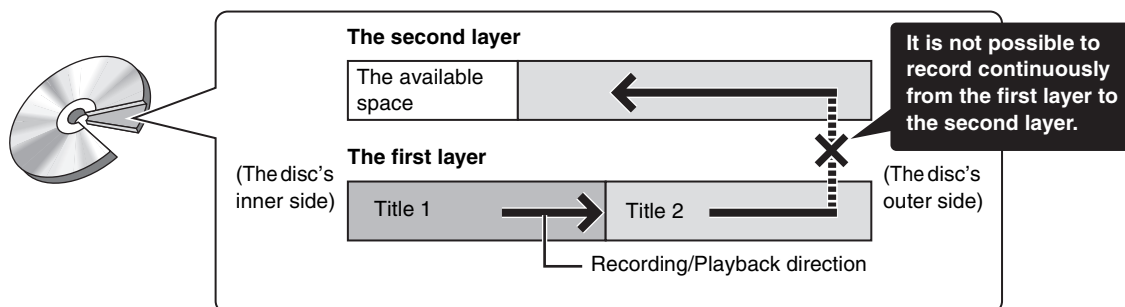

## Remote control

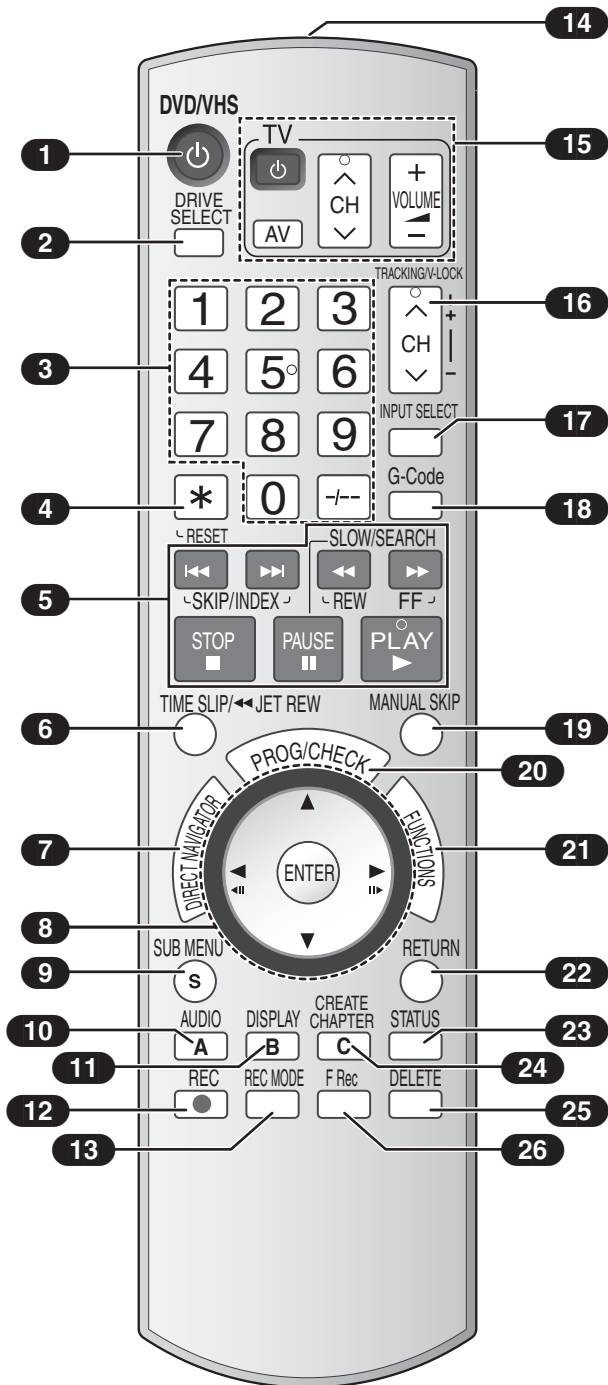

### ■ [DRIVE SELECT] button 2

#### DVD

- Before performing DVD operations, be sure to press [DRIVE SELECT] to select the DVD. Also, make sure the DVD indicator lights up on the unit.



#### VHS

- Before performing VHS operations, be sure to press [DRIVE SELECT] to select the VHS. Also, make sure the VHS indicator lights up on the unit.



- 1 Turn the unit on . . . . . → 14
- 2 Select drive (DVD or VHS) . . . . . → above
- 3 Select channels and title numbers etc./Enter numbers
- 4 Cancel/Reset the tape counter
- 5 Basic operations for recording and play
- 6 Skip the specified time . . . . . → 27  
Jet rewind button (◀◀ JET REW) . . . . . → 32
- 7 Show Top menu/Direct Navigator . . . . . → 26, 28, 37
- 8 Selection/Enter, Frame-by-frame . . . . . → 14, 27
- 9 Show sub menu. . . . . → 25, 30, 37, 41
- 10 Select audio/Release and put in standby/  
Delete a programme position. . . . . → 21, 25, 27, 60
- 11 Show DISPLAY menu  
Add a blank programme position . . . . . → 34, 60
- 12 Start recording . . . . . → 18, 45, 50
- 13 Change recording mode. . . . . → 18
- 14 Transmission window
- 15 TV operations . . . . . → 15, 21
- 16 Channel select. . . . . → 18  
TRACKING/V-LOCK. . . . . → 33
- 17 Input select (AV1, AV2 and DV) . . . . . → 50
- 18 For Australia and New Zealand Show G-CODE screen . . . . . → 23
- 19 Skip 30 seconds forward . . . . . → 26
- 20 Show timer recording programming screen . . . . . → 24
- 21 Show FUNCTIONS window . . . . . → 36
- 22 Return to previous screen
- 23 Show status messages . . . . . → 33, 36
- 24 Create chapters/Move a programme position . . . . . → 27, 60
- 25 Delete items. . . . . → 27, 41, 53
- 26 Start Flexible Recording. . . . . → 22

### Notes

- To stop them from being pressed accidentally, buttons such as [●, REC] do not protrude as much as other buttons.
- The word "button" is not used in these operating instructions so "Press the [ENTER] button." is shown as "Press [ENTER]."
- You can use this remote control to operate your TV if you set the TV manufacturer code (→ 15).

### ■ About batteries

- Insert so the poles (+ and -) match those in the remote control.
- Do not use rechargeable type batteries.

#### Do not:

- mix old and new batteries.
- use different types at the same time.
- heat or expose to flame.
- take apart or short circuit.
- attempt to recharge alkaline or manganese batteries.
- use batteries with the covering peeled off.

Mishandling of batteries can cause electrolyte leakage which can damage items the fluid contacts and may cause a fire.

Remove the batteries if the remote control is not going to be used for a long period of time. Store in a cool, dark place.

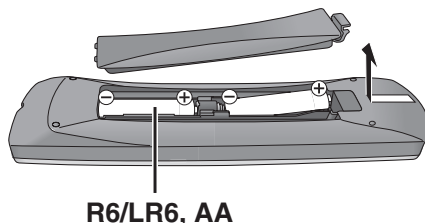

R6/LR6, AA

### ■ How to use the remote control

Aim at the sensor, avoiding obstacles, at a maximum range of 7 m directly in front of the unit.

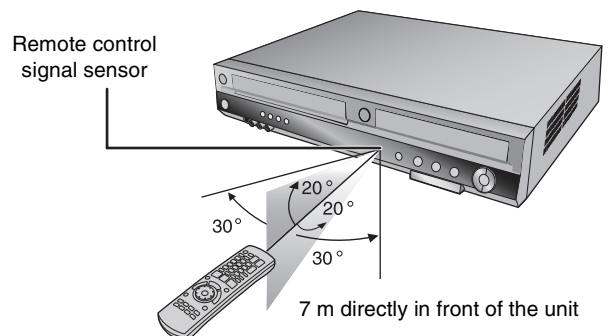

### Notes

- Keep the transmission window and the unit's sensor free from dust.
- Operation can be affected by strong light sources, such as direct sunlight, inverter fluorescent lamps and the glass doors on cabinets.
- If you cannot operate the unit or TV using the remote control after changing the batteries, please re-enter the codes (→ 15).

## Main unit

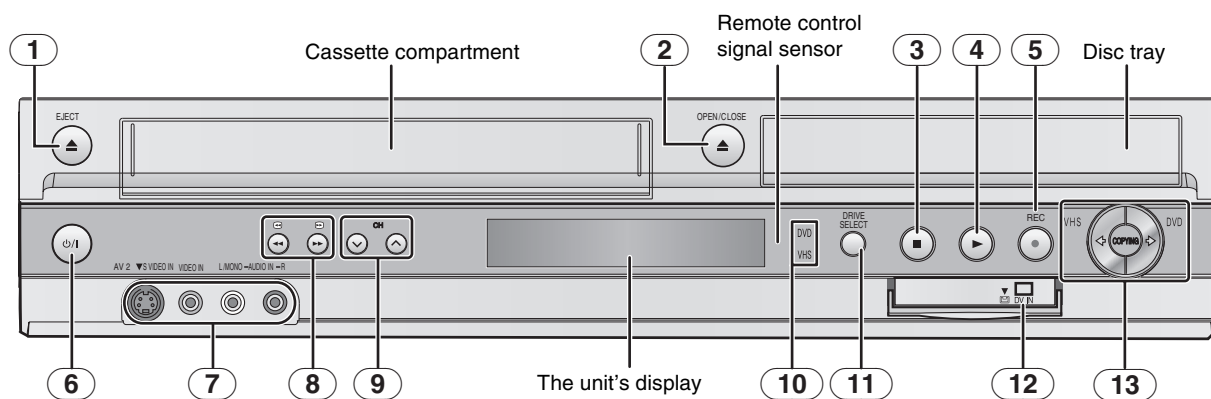

- |   |  |
|---|--|
| ① Cassette eject button (▲, EJECT)..... → 17                          | ⑩ DVD/VHS drive indicator ..... → 10                             |
| ② Disc tray open/close button (▲, OPEN/CLOSE) ..... → 17              | ● Lights when the DVD or VHS drive is selected.                  |
| ③ Stop button (■) ..... → 19, 32                                      | ⑪ DRIVE SELECT button ..... → 10                                 |
| ④ Play button (▶) ..... → 26  | ● The selected drive changes each time you press [DRIVE SELECT]. |
| ⑤ Recording button (●, REC) ..... → 18                                | ⑫ Connector for a digital video (DV) camera ..... → 50, 51       |
| ⑥ Standby/on switch (⏻/⏻) ..... → 14                                  | ⑬ One Touch Transfer (copying) operation button                  |
| Press to switch the unit from on to standby mode or vice versa.       | ● From VHS to DVD. .... → 45                                     |
| In standby mode, the unit is still consuming a small amount of power. | ● From DVD to VHS. .... → 47                                     |
| ⑦ AV2 input terminals (AV2) ..... → 50                                |  |
| ⑧ DVD-SEARCH ..... → 27, 29   |  |
| VHS-REW/FF buttons (◀/▶, ▶/▶) ..... → 32                              |  |
| ⑨ Channel up/down   |  |
| Tracking/V-Lock buttons (CH, v, ^) ..... → 14, 18, 33, 61             |  |

## The unit's display

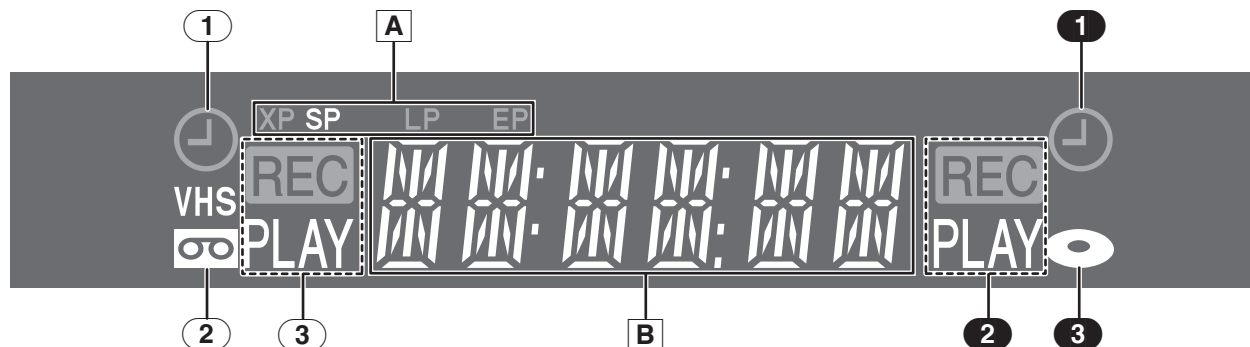

### Common to DVD/VHS

#### A Recording mode indicator

DVD: (→ 19)

- XP SP LP EP (all on): FR mode (→ 22)

VHS:(→ 19)

- SP: When recording or playing in Normal mode.
- LP: When recording or playing in Long play mode.
- EP: When recording or playing in Extra long play mode.

#### B Main display

- Current time
- Disc recording and play counter
- VHS recording and play counter
- Miscellaneous messages, etc.

### VHS

#### ① Timer recording indicator (⊕) (→ 23, 24)

On:

When a timer recording programme is registered and a recordable video cassette is inserted.

Flashes:

When the unit cannot record a timer recording programme (e.g., there is no video cassette, etc.).

#### ② Tape indicator

#### ③ Tape operation status

### DVD

#### ① Timer recording indicator (⊕) (→ 23, 24)

On:

When a timer recording programme is registered and a recordable disc is inserted.

Flashes:

When the unit cannot record a timer recording programme (e.g., there is no disc, etc.).

#### ② Disc operation status

#### ③ Disc indicator

# STEP 1 Connection

- Please read "IMPORTANT SAFETY INSTRUCTIONS". (→ 2)
- Before connection, turn off all equipment and read the appropriate operating instructions.

## Connecting a TV

For Saudi Arabia

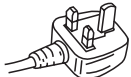

**BE SURE TO READ THE CAUTION FOR THE AC MAINS LEAD ON PAGE 2 BEFORE CONNECTION.**

To household Mains socket

For Australia and New Zealand

(AC 220 V to 240 V, 50 Hz)

For Asia and the Middle East

(AC 220 V to 240 V, 50/60 Hz)

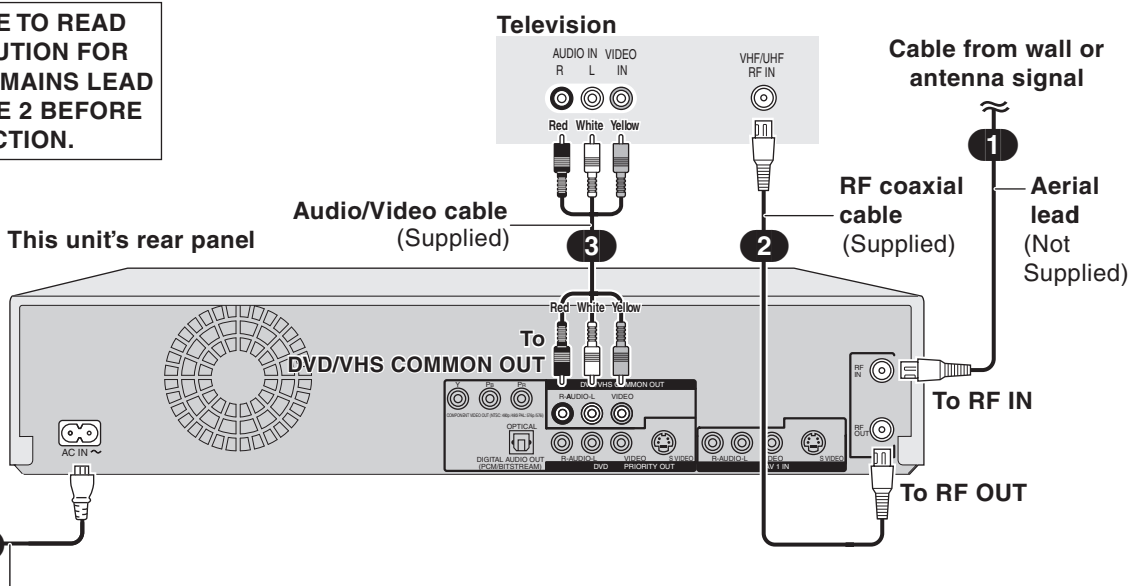

**AC mains lead (Supplied)**  
Connect only after all other connections are complete.

For the Middle East

Use the AC mains lead that matches the socket for your area you live in.

### ■ Connect in the following order

- 1 Aerial lead (not supplied)
- 2 RF Coaxial cable (supplied)
- 3 Audio/Video cable (supplied)
- 4 AC mains lead (supplied)

### ■ Connect the unit directly to the television

If you connect the unit to the television through an AV selector or a video cassette recorder, the video signals will be affected by copyright protection and the picture may not be shown correctly.

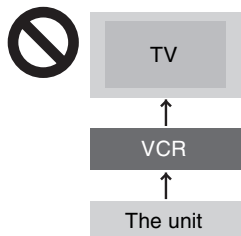

- When connecting the unit to a television with a built-in VCR, connect to the input terminals on the television, not the VCR.

### ■ When the unit is not to be used for a long time

To save power, unplug it from the household mains socket. The unit consumes a small amount of power even when it is turned off.

### Standby power consumption

		FL Display (→ 58)	
		Bright/Dim	Auto
Quick Start (→ 59)	On	Approx. 7.0 W	Approx. 6.8 W
	Off	Approx. 2.6 W	Approx. 2.5 W

- When "Power Save" is set to "On", the "Quick Start" function does not work.

### ■ Quick Start (→ 59)

1 Sec. Quick Start for Recording on DVD-RAM\*

\* From the power off state, recording on DVD-RAM starts about 1 second after first pressing the [⏪, DVD/VHS] and then sequentially pressing the [●, REC] (Quick Start Mode).

### ■ Connection examples with other equipment

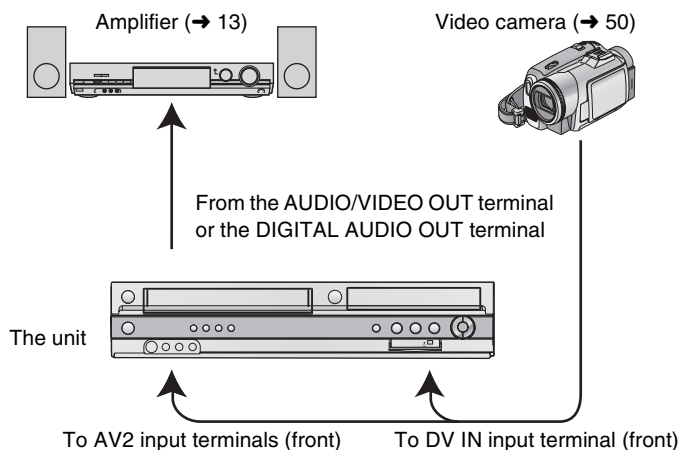

### For your reference

- The equipment connections described are examples.
- Peripheral equipment and optional cables are sold separately unless otherwise indicated.

## Connecting an amplifier or system component

### ■ Connecting an amplifier with a digital input terminal

To enjoy multi-channel surround sound on DVD-Video

- Connect an amplifier with a built-in Dolby Digital or DTS decoder displaying the logos on the right.



- Change the settings in "Digital Audio Output". (→ 58)
- Before purchasing an optical digital audio cable (not supplied), check the terminal shape of the connected equipment.
- You cannot use any amplifier with a DTS Digital Surround decoder not suited to DVD.
- Even if the unit is connected as illustrated, the output of DVD-Audio will only be in 2 channels.

- (1) Rear panel of the unit
- (2) Optical digital output terminal
- (3) **Optical digital audio cable** (not supplied)  
Do not bend when connecting.  
A Insert fully, with this side facing up.
- (4) Optical digital input terminal
- (5) Amplifier's rear panel

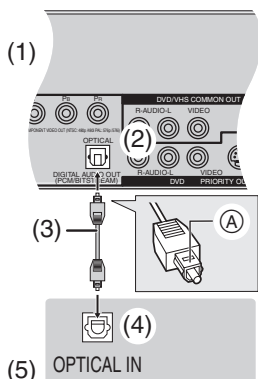

### ■ Connection to an analogue stereo amplifier

- (1) Rear panel of the unit
- (2) Audio output terminals (L/R)
- (3) Audio cable (not supplied)  
A Red (R)  
B White (L)
- (4) Audio input terminals (L/R)
- (5) Amplifier's rear panel

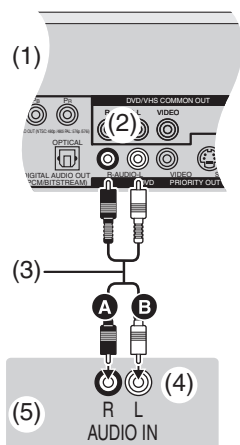

## DVD output and DVD/VHS output

The unit has DVD/VHS COMMON OUT terminals and DVD PRIORITY OUT terminals.

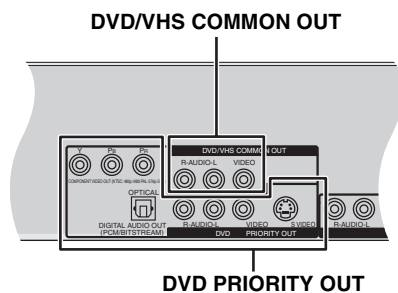

### DVD/VHS COMMON OUT

- For DVD/VHS COMMON OUT terminals, both DVD and VHS signals can be output.

### DVD PRIORITY OUT

- This is the dedicated terminal to enjoy pictures played on DVD in higher picture quality. (→ right)
- The DVD PRIORITY OUT terminals can also output the VHS signal. However this is not possible during DVD recording or DVD timer recording.

## To enjoy even higher fidelity

### ■ Connection to the TV's S Video terminal

#### S VIDEO OUT terminal

The S VIDEO OUT terminal achieves a more vivid picture than the VIDEO OUT terminal. (Actual results depend on the TV.)

After connecting the unit to the TV (→ 12), connect the S Video cable as illustrated below.

- (1) Audio input terminals (L/R)
- (2) S Video input terminal
- (3) Audio cable (not supplied)  
A Red (R)  
B White (L)
- (4) S Video cable (not supplied)
- (5) Rear panel of the unit
- (6) Audio output terminals (L/R)
- (7) S Video output terminal

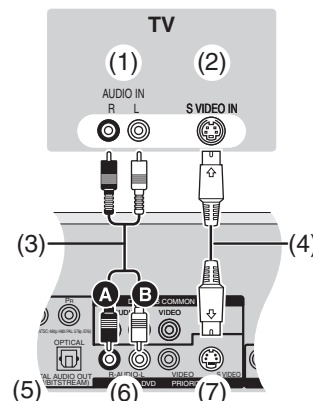

### ■ Connection to the TV's component video terminals

#### COMPONENT VIDEO OUT terminal

These terminals can be used for either interlace or progressive output (→ 62) and provide a purer picture than the S VIDEO OUT terminal. Connection using these terminals outputs the colour difference signals (PB/PR) and luminance signal (Y) separately in order to achieve high fidelity in reproducing colours.

If the TV is compatible with progressive output, a high quality picture can be output because the unit's component video output terminal outputs a progressive output signal.

- **For progressive output** (→ 16)

After connecting the unit to the TV (→ 12), connect the video cable as illustrated below.

- Connect to terminals of the same colour.

- (1) Component input terminals
- (2) Audio input terminals (L/R)
- (3) Video cables (not supplied)
- (4) Audio cable (not supplied)  
A Red (R)  
B White (L)
- (5) Rear panel of the unit
- (6) Component video output terminals
- (7) Audio output terminals (L/R)

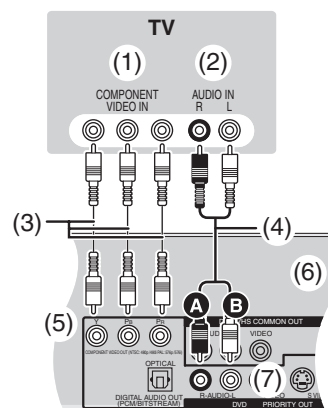

# STEP 2 Auto-Setup

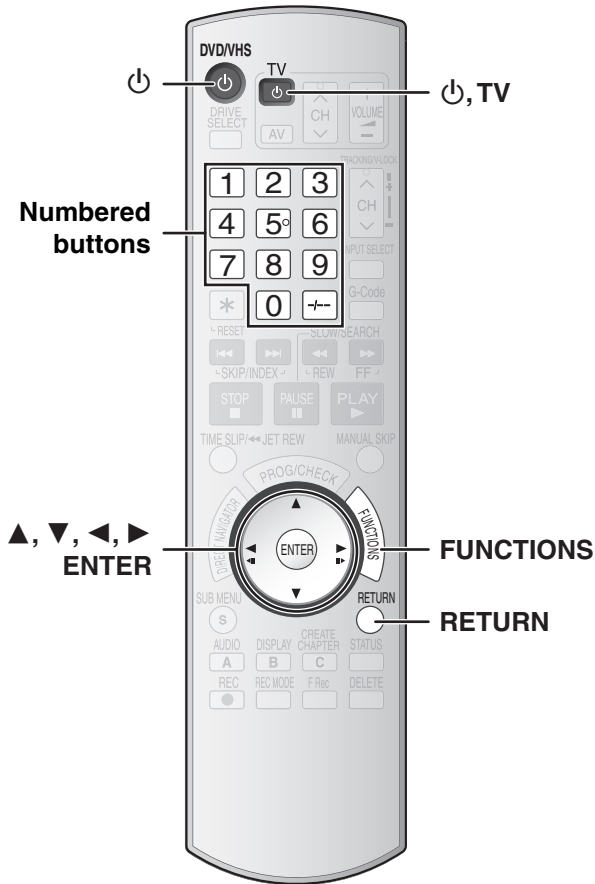

## Auto-Setup

Auto-Setup automatically tunes all available stations.

- 1 **Switch on the TV.**
- 2 **Select the AV input on your TV.**
- 3 **Press [⏻, DVD/VHS] to switch the unit on.**
- 4 **For Asia and the Middle East**

Auto-Setup starts automatically.  
Skip to step 5.

**For Australia and New Zealand**

Press [▲, ▼] to select the country and then press [ENTER].

- The pre-set channel settings are used and the clock setting menu appears when "Australia" is selected. However, Auto-Setup starts when "New Zealand" or "Others" is selected.



Auto-Setup starts. This takes about 8 minutes.



Auto-Setup is complete when you see the clock setting menu.

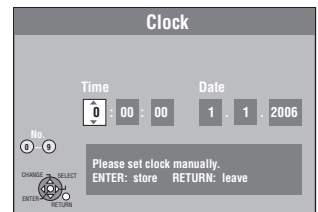

- 5 **Press [◀, ▶] to select the item you want to change and then press [▲, ▼] to change the setting.**

This is a 24-hour clock.

The items change as follows:

Hour ↔ Minute ↔ Second ↔ Day ↔ Month ↔ Year

↑

Reset the clock regularly to maintain accuracy (→ 61).

- You can also use the numbered buttons for setting.

- 6 **Press [ENTER] when you have finished the settings.**

After the clock settings are complete the TV aspect setting screen appears.

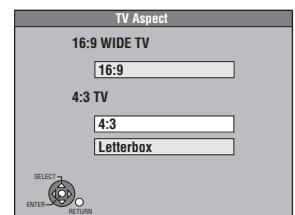

- 7 **Press [▲, ▼] to select the TV aspect and then press [ENTER].**

- **16:9:** 16:9 widescreen television

- **4:3:** 4:3 aspect television

**RAM** Titles are recorded as they appear on the screen.

**DVD-V** Video recorded for a widescreen is played as Pan & Scan (unless prohibited by the producer of the disc) (→ 62).

- **Letterbox:** 4:3 aspect television

Widescreen picture is shown in the letterbox style (→ 62).

### ■ To stop in the middle

Press [RETURN].

*To change the channel settings* (→ 60)

*To change the TV aspect settings* (→ 59)

*To restart Auto-Setup* (→ 61)

You can also use the following method to restart Auto-Setup.

When the unit is on and stopped.

**Press and hold down [CH, ▼] and [CH, ▲] on the main unit simultaneously for about 5 seconds.**

- All the settings except for the ratings level including the password and time settings return to the factory preset. The timer recording programmes are also cancelled.



# STEP 3 Set up to match your TV and remote control

## When other Panasonic products respond to this remote control

If you place other Panasonic products close together, change the remote control code on the main unit and on the remote control (the two must match). When changing the remote control code, make sure the two codes are the same.

Use "DVD 1", the factory set code, under normal circumstances.

- 1 While stopped  
Press [FUNCTIONS].
- 2 Press [▲, ▼] to select "To Others" and then press [ENTER].
- 3 **For Australia and New Zealand**  
Press [▲, ▼] to select "Setup" and then press [ENTER].  
**For Asia and the Middle East**  
Check that "Setup" is selected and then press [ENTER].  
• If a disc is inserted and "Setup" is not selected, press [▲, ▼] to select "Setup" and then press [ENTER].
- 4 Press [▲, ▼] to select "Others" and then press [◀, ▶].
- 5 Press [▲, ▼] to select "Remote Control" and then press [ENTER].
- 6 Press [▲, ▼] to select the code ("DVD 1", "DVD 2" or "DVD 3") and then press [ENTER].  
• The code on the unit has been set.
- 7 While pressing [ENTER], press and hold for about 2 seconds the numbered button ([1], [2] or [3]) corresponding to the code you selected in step 6.  
• The code on the remote control has been set.
- 8 Press [ENTER].

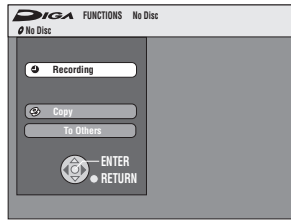

## When the following indicator appears on the unit's display



The unit's remote control code

Change the code on the remote control to match the main unit's code (→ step 7).

## To return to the previous screen

Press [RETURN].

## Selecting the television type

Choose the setting to suit your television and preference.

- 1 While stopped  
Press [FUNCTIONS].
- 2 Press [▲, ▼] to select "To Others" and then press [ENTER].
- 3 **For Australia and New Zealand**  
Press [▲, ▼] to select "Setup" and then press [ENTER].  
**For Asia and the Middle East**  
Check that "Setup" is selected and then press [ENTER].  
• If a disc is inserted and "Setup" is not selected, press [▲, ▼] to select "Setup" and then press [ENTER].
- 4 Press [▲, ▼] to select "Connection" and then press [◀, ▶].
- 5 Press [▲, ▼] to select "TV Aspect" and then press [ENTER].

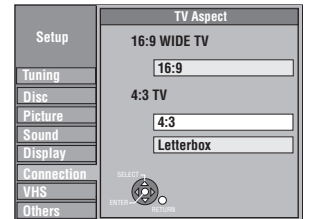
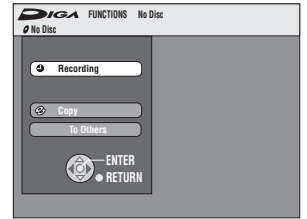

- 6 Press [▲, ▼] to select the TV aspect and then press [ENTER].  
• 16:9: 16:9 widescreen television  
• 4:3: 4:3 aspect television  
**RAM** Titles are recorded as they appear on the screen.  
**DVD-V** Video recorded for a widescreen is played as Pan & Scan (unless prohibited by the producer of the disc) (→ 62).  
• **Letterbox**: 4:3 aspect television  
Widescreen picture is shown in the letterbox style (→ 62).

## Television operation

Set the remote control as follows to turn the TV On/Off, change the TV input mode, select the TV channel and change the TV volume by means of this remote control.

### Point the remote control at the TV

While pressing [⏻, TV], enter the code using the numbered buttons.

e.g., 02: press [0] → [2].

### Manufacturer and Code No.

Brand	Code
Panasonic/National	01/02/03/04
GOLDSTAR/LG	15/16
HITACHI	08
JVC	07
mitsubishi	09/10
NEC	13
PHILIPS	12
SAMSUNG	17/18
SANYO	14/19
SHARP	11
SONY	05
TOSHIBA	06

- Test by turning on the TV and changing channels. Repeat the procedure until you find the code that allows correct operation.
- This remote control is not compatible with your TV if your TV brand is not listed or if the code listed for your TV does not allow control of your TV.

## To exit the screen

Press [RETURN] several times.

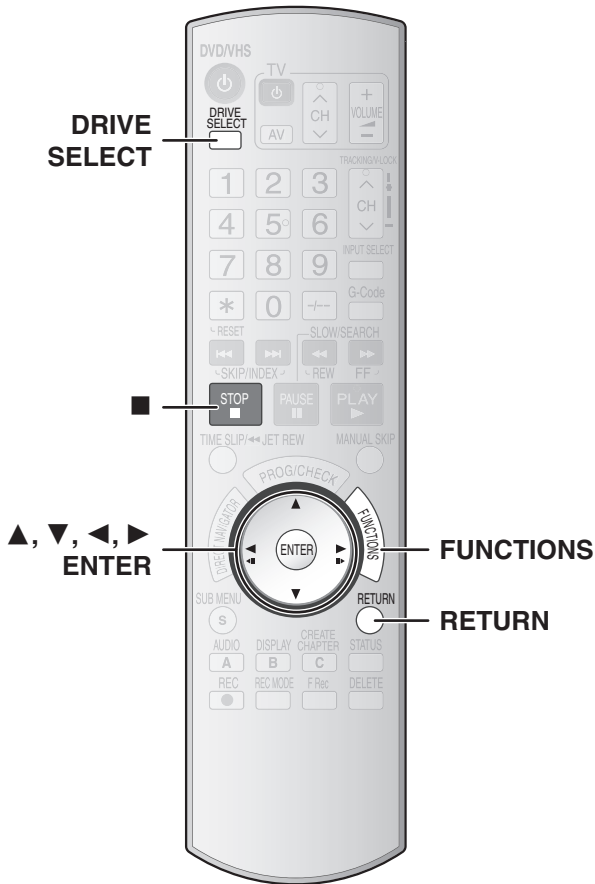

**Note to owners of progressive compatible PAL system televisions**

● **If you have an LCD/plasma television or LCD projector**  
Using progressive output, you can enjoy high-resolution video recorded on media such as DVD-Video. Connect this unit's component video output terminals to your television and turn on the progressive output setting (→ 13).

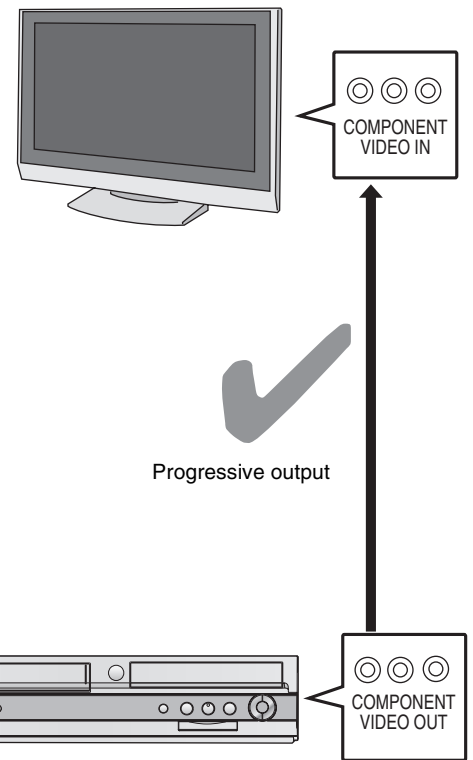

**To enjoy progressive video**

You can enjoy progressive video by connecting the unit's COMPONENT VIDEO OUT terminals to an LCD/plasma television or LCD projector compatible with progressive scan (→ 62).

- 1 While stopped Press [FUNCTIONS].
- 2 Press [▲, ▼] to select "To Others" and then press [ENTER].
- 3 Press [▲, ▼] to select "Setup" and then press [ENTER].
- 4 Press [▲, ▼] to select "Connection" and then press [◀, ▶].
- 5 Press [▲, ▼] to select "Progressive" and then press [ENTER].
- 6 Press [▲, ▼] to select "On" and then press [ENTER].  
Output becomes progressive.

**Notes**

- When connected to a regular television (CRT: Cathode Ray Tube) or a multi system television using PAL mode, even if it is progressive compatible, progressive output can cause some flickering. Turn off "Progressive" if this occurs (→ 35).
- If the unit is connected to the television through VIDEO OUT or S VIDEO OUT terminal, output will be interlace irrespective of the settings.

**To return to the previous screen**

Press [RETURN].

**To exit the screen**

Press [RETURN] several times.

● **If you have a regular television (CRT: Cathode Ray Tube)**

Use component output with progressive "Off" (factory setting → 59), even if the television is progressive compatible. Progressive output can cause some flickering. This is the same for multi system televisions using the PAL mode.

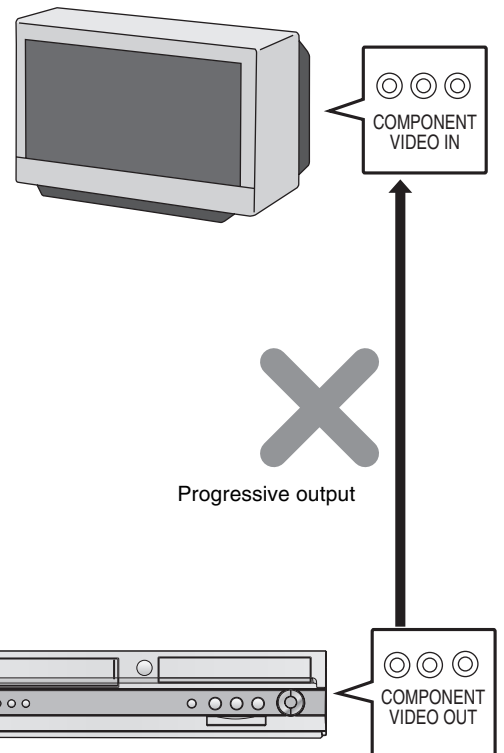

## Inserting a disc

- 1 Press [▲, OPEN/CLOSE] on the main unit to open the tray.**
  - You can insert a cartridge or non-cartridge disc.
- 2 Press [▲, OPEN/CLOSE] on the main unit to close the tray.**
  - If you insert a DVD-RAM with the write-protect tab set to "PROTECT" (→ 55), play starts automatically.

### Notes

- A double-sided disc should be loaded with the side you want to record/play facing down.
- It is not possible to record continuously from one side of a double-sided disc to the other. You will need to eject the disc and turn it over.
- When using 8 cm DVD-RAM or 8 cm DVD-R, remove the disc from the cartridge.

#### Non-cartridge disc

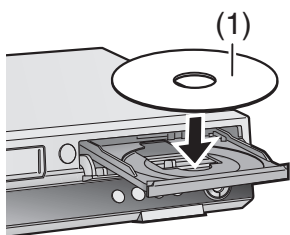

- (1) Insert label-up.
- (2) Insert fully so it clicks into place.
- (3) Insert label-up with the arrow facing in.

#### Cartridge disc

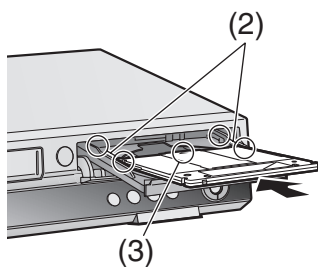

## Inserting a video cassette

The surface on which you can see a roll of tape should face up.

### Insert a video cassette.

- The unit is automatically turned on.
- Play starts automatically if you insert a video cassette without the accidental erasure prevention tab.

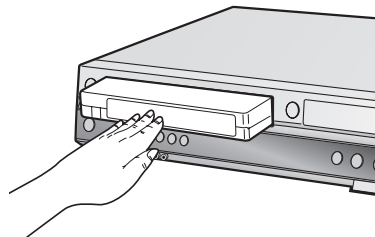

### To eject a video cassette

- You can eject a video cassette even when the unit is in standby mode. It switches back to standby once it ejects the video cassette.

#### For main unit

- Press [▲, EJECT] on the main unit.

#### For remote control

- Press [DRIVE SELECT] to select the VHS and then press and hold [■, STOP] for about 3 seconds or more.

## Before recording

### +RW

- The created title menu is deleted when recording on the disc. Create the title menu again by using "Create Top Menu" in DVD Management. (→ 55)

### VHS

#### Video cassette care

- Poor quality or damaged video cassettes can cause the heads to become dirty and malfunction. Store your video cassettes carefully and discard them when they become dirty or damaged.
- Never use video cassettes on which juice has been spilled or those that are extremely damaged since this will not only cause the heads to become dirty, but will also make the unit malfunction.

#### Video cassette maintenance

##### Cleaning the video heads

Dirt on the video heads can cause poor recording and play.

- If the picture does not improve, use an optional head-cleaning cassette. If the problem persists seek advice from a qualified service personnel.



## After recording

### DVD

Finalize (→ 56) the disc to make it playable on other equipment or set the protection (→ 55) so that you do not accidentally erase the contents.

### VHS

- Break off the video cassette's tab to prevent accidental erasure. Cover the hole with a double layer of adhesive tape when you want to use the video cassette for recording again.
- You can use video cassettes with the VHS and S-VHS marks, but the unit is unable to make full use of the characteristics of S-VHS video cassettes.

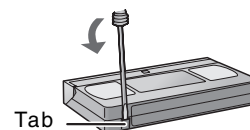

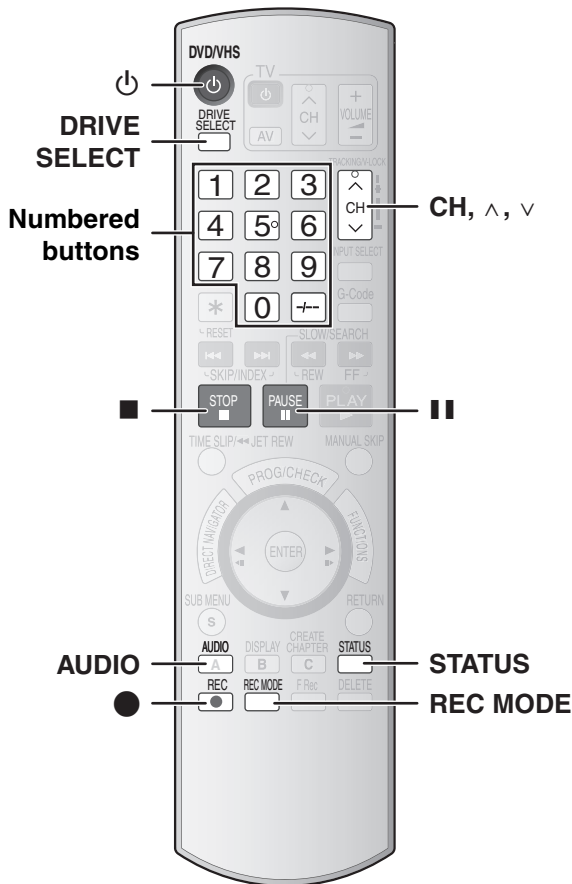

**Preparation**

- Select the unit viewing channel (e.g., AV input) on the TV.
- **RAM** Release protection (disc → 55, cartridge → 55).
- Press [⏻, DVD/VHS] to turn the unit on.
- Press [DRIVE SELECT] to select the drive you want to record on (DVD or VHS).
- Select the audio type you want to record. (→ 21)

**1 Insert a disc.** (→ 17)

- If the "Format" screen appears (→ 20, When the format confirmation screen is displayed).
- When using a DVD-RAM for the first time with this unit, format it to ensure accurate recording (→ 55, Format Disc)

or  
**Insert a video cassette with an intact accidental erasure prevention tab.** (→ 17)

**2 Press [CH, ^, v] to select the channel.**



To select with the numbered buttons:

- e.g., 5: [5]
- 15: [-/-] → [1] → [5]

**3 Press [REC MODE] to select the recording mode.**



Remaining time on the disc

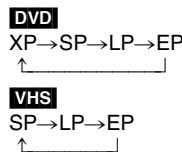

**4 Press [●, REC] to start recording.**



e.g., **DVD**



- You cannot change the channel or recording mode during the recording. However you can change them while the recording is paused, but the recording is divided into a separate title.
- You can record while the unit is in standby for timer recording, but once the time for timer recording to begin is reached, any recording taking place will stop and the timer recording will begin.
- **RAM** You can change the audio being received by pressing [AUDIO] during the recording. (This does not affect the actual audio being recorded.)

**Recording procedures**

**RAM -R -R DL -RW(V) +R +R DL +RW VHS**

**RAM -R -R DL -RW(V)**

- You can record up to 99 titles on a disc.
- **+R +R DL +RW**
- You can record up to 49 titles on a disc.
- It is not possible to record digital broadcasts that allow "One time only recording" onto DVD-R, DVD-R DL, DVD-RW, +R, +R DL, +RW or 8 cm DVD-RAM discs. Use a CPRM compatible DVD-RAM.
- The recording will take place on the open space in the disc. Existing data will not be overwritten.
- If there is no space left on the disc you intend to record on, you will need to delete unwanted titles (→ 27, 37) or use a new disc.

**When recording to DVD-R, DVD-R DL, DVD-RW (DVD-Video format) +R, +R DL or +RW**

- When recording bilingual TV broadcasts
  - If you are not recording from external equipment Select "M 1" or "M 2" in "Bilingual Audio Selection" in the Setup menu (→ 58).
  - If you are recording from external equipment Select M 1 or M 2 on the external equipment.
- The aspect ratio of the recorded image will be 4:3.
- **In order to play a DVD-R, DVD-R DL, DVD-RW (DVD-Video format) +R, +R DL or +RW recorded with this unit on other playback equipment, the disc must first be finalized** (→ 56).
- **+RW** To enable play on other DVD equipment, use "Create Top Menu" in the DVD Management menu (→ 55).

### ■ To pause recording

Press [II, PAUSE]. (Press again to restart recording.)

- **RAM** Title is not split into separate titles.
- You can also press [●, REC] to restart recording.

### ■ To stop recording

Press [■, STOP].

- **DVD** Recorded as 1 title until the position where stopped.
- **R -R DL -RW(V) +R +R DL +RW**  
It takes about 30 seconds for the unit to complete recording the management information after the recording finishes.

### ■ To show the remaining time

#### DVD

Press [STATUS] several times. (→ 36)

#### VHS

Make sure that the corresponding video cassette length is correctly selected for "Tape Length" in the Setup menu.

Press [STATUS] several times. (→ 36)

- The remaining time may not be displayed correctly depending on the video cassette being used.

#### Notes

##### VHS

- Even if the video cassette is labelled "S-VHS", it is not possible to record in the S-VHS system with this unit.  
This unit records in the normal VHS system.
- When recording is paused for 5 minutes or more, the unit returns to stop.

## ■ Recording modes and approximate recording times

### ■ DVD recording modes

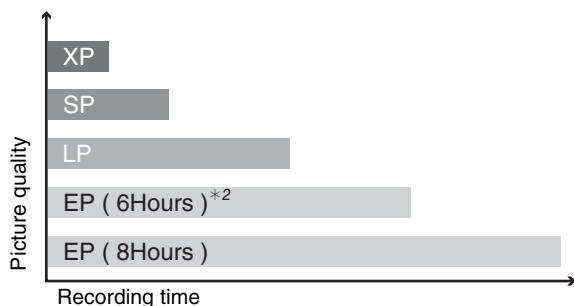

	DVD-RAM		DVD-R DVD-RW +R, +RW (4.7 GB)
	Single-sided (4.7 GB)	Double-sided*1 (9.4 GB)	
XP (High quality)	1 h	2 h	1 h
SP (Normal)	2 h	4 h	2 h
LP (Long play)	4 h	8 h	4 h
EP (Extra long play)	8 h (6 h*2)	16 h (12 h*2)	8 h (6 h*2)
FR (Flexible Recording)	8 h maximum	8 h maximum on one side	8 h maximum

	DVD-R DL*3, +R DL*3 (8.5 GB)	
	First layer	Second layer
XP (High quality)	55 min	50 min
SP (Normal)	1 h 50 min	1 h 40 min
LP (Long play)	3 h 40 min	3 h 20 min
EP (Extra long play)	7 h 25 min (5 h 30 min*2)	6 h 50 min (5 h 15 min*2)
FR (Flexible Recording)	7 h 25 min maximum	6 h 50 min maximum

This unit uses variable bit rate (VBR) recording which varies the amount of data recorded to suit the images, so actual recording times and remaining recording times shown by the unit will be different. (The difference will be especially noticeable with DVD-R DL and +R DL.)

Use a disc with plenty of remaining time to be sure.

\*1 It is not possible to record continuously from one side of a double sided disc to the other.

\*2 When "Recording time in EP mode" is set to "EP( 6Hours )" in the Setup menu.

The sound quality is better when using "EP( 6Hours )" than when using "EP( 8Hours )".

\*3 It is not possible to record continuously from the first layer to the second layer.

#### Note

When recording to DVD-RAM using "EP ( 8Hours )" mode, play may not be possible on DVD players that are compatible with DVD-RAM. In this case use "EP ( 6Hours )" mode.

#### FR (Flexible Recording mode → 22):

- You can set FR mode when transferring (copying) or programming timer recordings.

#### ■ Quick Start (→ 59)

1 Sec. Quick Start for Recording on DVD-RAM\*

\* From the power off state, recording on DVD-RAM starts about 1 second after first pressing the [⏏, DVD/VHS] and then sequentially pressing the [●, REC] (Quick Start Mode).

"Quick Start" is set to "On" at the time of purchase.

#### Note

- Startup takes up to a minute when:
  - You play a disc or start recording to discs other than DVD-RAM.
  - You want to make other operations.

### ■ VHS recording modes

#### Recording mode

SP: When recording or playing in the Normal mode.

LP: When recording or playing in the Long play mode.

EP: When recording or playing in the Extra long play mode.

- To have a longer recording capacity, select "LP" or "EP".
- If the image quality is important to you or if you wish to store the video cassette for a long period, select "SP".

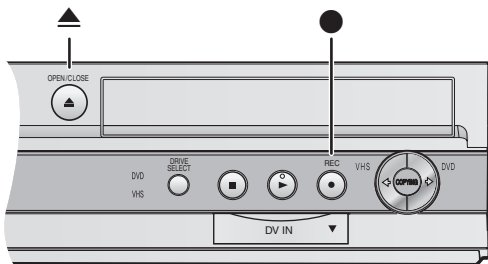
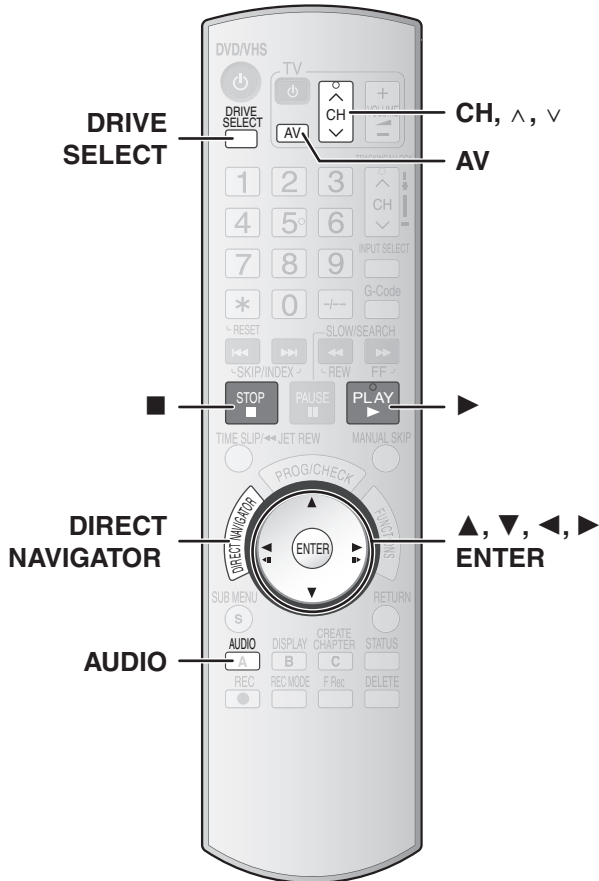

**■ When the format confirmation screen is displayed**

**RAM -RW(V) +R +R DL +RW**

When you insert a new disc or a disc recorded on a computer or other equipment, a format confirmation screen might be displayed. Format the disc to use it. However all the recorded contents will be deleted.

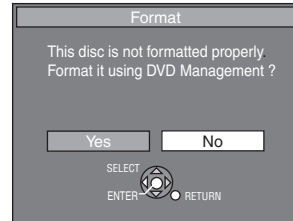

Press [**◀**] to select "Yes" and then press [ENTER].

- Several steps are necessary to format a disc. Refer to "Format Disc" (→ 55).

**■ When removing a recorded disc**

**-R -R DL -RW(V) +R +R DL**

When you press [**▲**, OPEN/CLOSE] on the main unit:

The following screen appears when you have not processed the disc for play on other equipment.

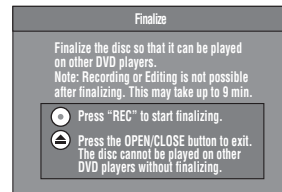

**To finalizing the disc**

Press [**●**, REC] on the main unit.

- You cannot stop this process once you have started it.
- If you want to provide the disc with a name or set a play menu, select "Disc Name" (→ 54) or "Auto-Play Select" (→ 55) before finalizing.

**When opening the tray without disc finalization**

Press [**▲**, OPEN/CLOSE] on the main unit.



## Specifying the time when recording will stop

RAM -R -R DL -RW(V) +R +R DL +RW VHS

While recording

Press [●, REC] on the main unit to select the recording time.

### The unit's display

Each time you press the button:

Counter (cancel) → OFF 0:30 → OFF 1:00 → OFF 1:30  
 ↑ OFF 4:00 ← OFF 3:00 ← OFF 2:00 ←

### For your reference

- This does not work during timer recording or Flexible Recording.
- **DVD** The set time is cleared if you change the recording mode or channel while recording is paused.
- Recording stops and the set time is cleared if you press [■, STOP].
- If the unit is not being used when the recording stops, the unit will automatically turn off.

## Select audio to record

-R -R DL -RW(V) +R +R DL +RW

Select the main (M 1) or secondary (M 2) audio type in "Bilingual Audio Selection" in the Setup menu. (→58)

## Playing DVD while recording VHS

You can play discs while recording VHS. The recording will not be affected.

- DVD playback (→ 26)

### For your reference

- You cannot record on discs while recording on VHS.

## Playing VHS while recording DVD

You can play video cassettes while recording to discs. The recording will not be affected.

- VHS playback (→ 32)

### For your reference

- You cannot record on video cassettes while recording on DVD.

## Watching the TV while recording

RAM -R -R DL -RW(V) +R +R DL +RW VHS

**1** Press [AV] to change the input mode to "TV".

**2** Press TV's [CH, ^, v] to select the desired TV channel.

### For your reference

- You can also do this if the unit is making a timer recording.
- The recording is not affected.

## Playing while you are recording

RAM

### Preparation

- Press [DRIVE SELECT] to select the DVD.

### Hint

- Sound is not output while fast-forwarding.

### ■ Playing from the beginning of the title you are recording—Chasing play

You can start play from the beginning of the title while continuing to record it.

### While recording or timer recording

Press [▶, PLAY].

- Play starts while recording proceeds.

### For your reference

- Play cannot be started until at least 2 seconds after recording starts.

### ■ Play a title previously recorded while recording—Simultaneous rec and play

You can play a title previously recorded while you are recording another title.

### 1 While recording or timer recording

Press [DIRECT NAVIGATOR].

●: Currently recording

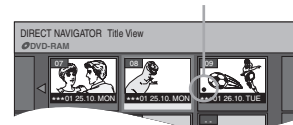

**2** Press [▲, ▼, ◀, ▶] to select a title and then press [ENTER].

- Play starts while recording proceeds.

### ■ To exit the Direct Navigator screen

Press [DIRECT NAVIGATOR].

### For your reference

- During simultaneous recording and play, you cannot edit or delete titles with the Direct Navigator or playlists.
- Even if you start play while the unit is on standby for timer recording, recording starts when the time you set is reached.

### ■ To stop play and recording

**1** Press [■, STOP]. Play stops.  
(Wait 2 seconds or more.)

**2** Press [■, STOP]. Recording stops.

- When recording with timer record a confirmation screen appears. Press [◀] to select "Stop Recording" and the press [ENTER].

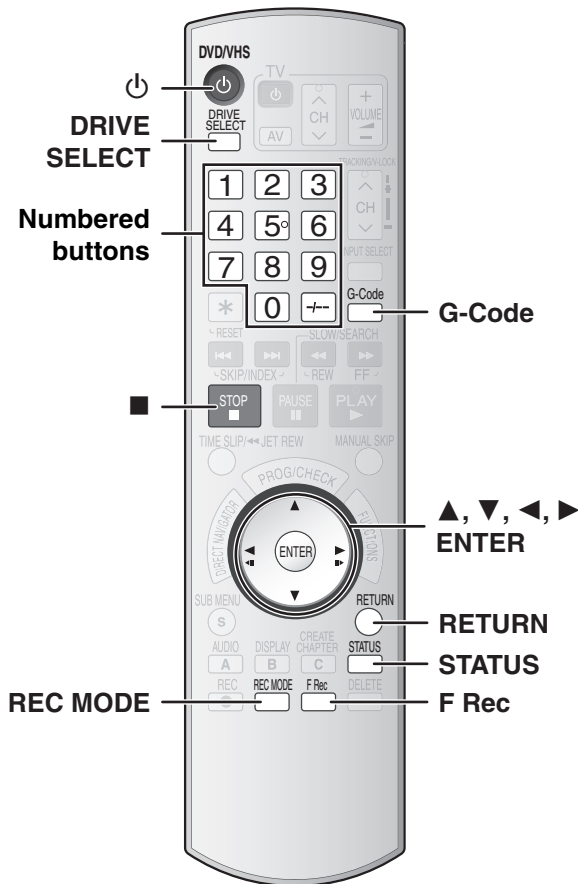

### Flexible Recording mode (FR)

RAM -R -R DL -RW(V) +R +R DL +RW

The unit calculates a recording rate that enables the recording to fit in the time you set (within the remaining time on the disc) with the best picture quality.

#### Using "Flexible Rec" is convenient in the following situations.

- When the amount of free space on the disc makes selecting an appropriate recording more difficult.
- When you want to record a long programme with the best picture quality possible.

e.g., Recording a 90 minute programme to disc  
If you select XP mode, the programme will not fit on one disc.

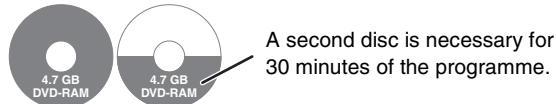

If you select SP mode, the programme will fit on one disc.

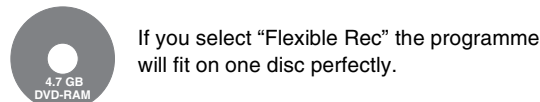
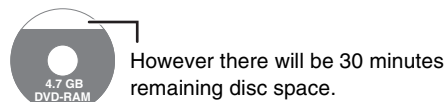

#### Preparation

- Press [DRIVE SELECT] to select the DVD.
- Select the channel to record.

- 1 While stopped  
Press [F Rec].

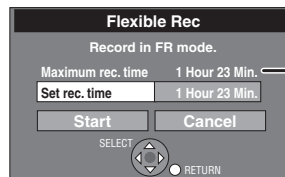

Maximum recording time  
This is the maximum recording time in FR mode.

- 2 Press [◀, ▶] to select "Hour" and "Min." and then press [▲, ▼] to set the recording time.
  - You can also set the recording time with the numbered buttons.
  - Maximum recording time is 8 hours. (This depends on disc capacity.)
- 3 When you want to start recording  
Press [▲, ▼, ▶, ◀] to select "Start" and then press [ENTER].
  - Recording starts.

#### ■ To exit the Flexible Rec window without recording

Press [RETURN].

#### ■ To stop recording in the middle

Press [■, STOP].

#### ■ To show the time remaining until the recording finishes

Press [STATUS] several times. (→ 36)

- The remaining time is displayed in hours and minutes.



#### For your reference

- During a Flexible Recording, all recording mode indicators light up on the unit's display.
- It is not possible to change the channel or recording mode while Flexible Recording is paused.

## Cautions for using timer recording

- **Timer recording automatically starts at the set time.**
- Timer recording can be started whether the unit is on or off. When the unit is turned off the sound and the video cannot be output to the TV.
- **Timer recording cannot be executed on both DVD and VHS at the same time.**
- Make sure that the timer recording times do not overlap on the Timer Recording screen. (→ 25)

When the timer recording settings overlap:

- Recording of the programme with the later start time starts when the earlier programme finishes recording.
- If there is a VHS timer recording that overlaps a DVD timer recording that is currently being recorded, it may not be possible to operate the VHS during the overlap.

## Timer Recording

**RAM -R -R DL -RW(V) +R +R DL +RW VHS**

It is possible to enter a total of 16 DVD and VHS programmes a month in advance.

### Preparation

- Select the unit viewing channel (e.g., AV input) on the TV.
- Check that the clock is set to the correct time. If it has not been set, set it (→ 61).
- **RAM** Release protection (disc → 55, cartridge → 55).
- Insert a disc (→ 17) and confirm there is sufficient empty space for recording on it (→ 36).
- Insert a video cassette with an intact accidental erasure prevention tab. (→ 17)
- **-R -R DL -RW(V) +R +R DL +RW** When recording bilingual broadcasts, only the audio selected in "Bilingual Audio Selection" (→ 58) is recorded ("M 1" or "M 2").
- Press [DRIVE SELECT] to select the drive you want to record on (DVD or VHS).

For Australia and New Zealand

## Using G-CODE system

Entering the G-CODE® numbers is an easy way of timer recording. You can find these numbers in the TV listings in newspapers and magazines.

### 1 Press [G-Code].

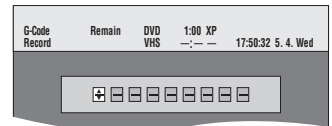

### 2 Press the numbered buttons to enter the G-CODE number.

- Press [◀] to move back and correct a digit.

### 3 Press [ENTER].

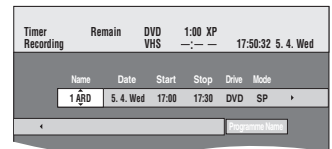

- Confirm the programme and make corrections if necessary by pressing [▲, ▼, ◀, ▶] ("Manual programming" → 24, step 3).
- **Mode** (Recording mode)

#### DVD

XP↔SP↔LP↔EP↔FR (→ 19)

#### VHS

SP↔LP↔EP↔AUTO (→ 19, 25)

You can also press [REC MODE] to change the recording mode.

#### To enter the name of the programme

Press [◀, ▶] to select "Programme Name" and press [ENTER] (→ 52).

- If "—" appears under "Name", press [▲, ▼] to select a desired programme position. After you have entered the information of a TV station, it is kept in the unit's memory.
- "Invalid Entry" is displayed when you enter the wrong G-CODE number. Re-enter the G-CODE number.

### 4 If the programme is correct

#### Press [ENTER].

The settings are stored and the programme goes to timer recording standby.

The Timer Recording icon is displayed in the left column.

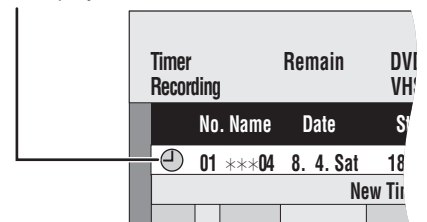

- "⏸" lights on the unit's display.
- Make sure that the timer recording has been programmed correctly on the Timer Recording screen (→ 25).
- Repeat steps 1 to 4 to programme other recordings.

#### The timer recording standby mode is activated.

However, the unit may not turn off automatically.

- If a timer recording starts while the unit is turned on, the unit will not automatically turn off after the timer recording is complete. To save power turn the unit off by pressing [⏻, DVD/VHS]. You can turn the unit off during timer recording. This will not affect the recording.

#### Notes

Refer to "Notes on timer recording" (→ 24).

G-CODE is a registered trademark of Gemstar Development Corporation. The G-CODE system is manufactured under license from Gemstar Development Corporation.

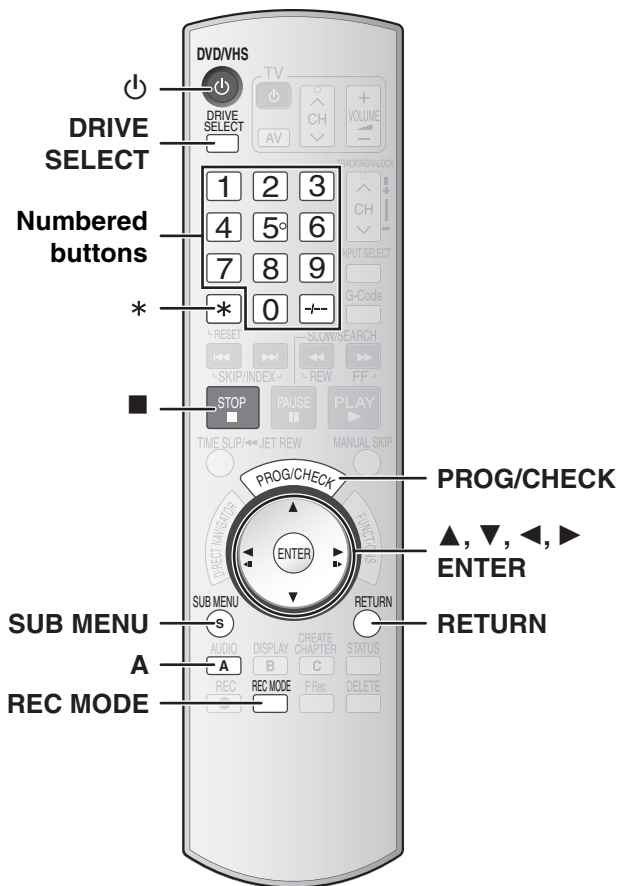

**Notes on timer recording**

- “⊖” flashes when the unit cannot go to timer recording standby (non-recordable disc or protected disc, etc.). Check the disc or video cassette carefully.
- When the disc or video cassette is removed, timer recording standby is cancelled (the “⊖” indicator goes out). You can put the unit back on standby by inserting a recordable disc or video cassette (the “⊖” indicator comes on again).
- If the unit is not put in the timer recording standby mode at least 10 minutes before the programmed timer recording starting time, the “⊖” indicator flashes on the unit’s display. In this case, insert a recordable disc or video cassette to put the unit in the timer recording standby mode.
- When you set successive timer recordings to start immediately one after the other, the unit cannot record the part at the beginning of the later programmes (a few seconds when recording with DVD-RAM and approximately 30 seconds when recording with DVD-R, DVD-R DL, DVD-RW, +R, +R DL and +RW).
- You can play or record on DVD, play or record on VHS even if the timer recording standby mode is activated.
- Timer recording can be started whether the unit is turned on or off.
- When the timer recording starts while the unit is turned on, the unit will not automatically turn off after the timer recording is complete. To save power turn the unit off by pressing [⊖, DVD/VHS]. You can turn the unit off during timer recording. This will not affect the recording.

**Manual programming**

**1 Press [PROG/CHECK].**

- Make sure “New Timer Programme” is selected.

“New Timer Programme” is selected.

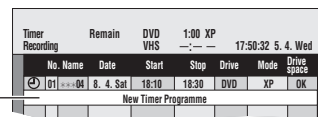

**2 Press [ENTER].**

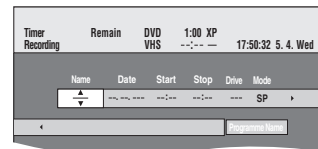

**3 Press [◀, ▶] to select the item then press [▲, ▼] to change the settings.**

- You may use the numbered buttons to enter “Name”, “Date”, “Start” and “Stop”.

- **Name** (Programme Position/TV Station Name)

- **Date**

You can also make a daily or weekly programme.

Each daily or weekly programme is counted as one programme.

- **Start** (start time)/**Stop** (finish time)

The time increases or decreases in 30-minute intervals if you press and hold the button.

- **Drive**

You can select the DVD or VHS drive.

You can also press [DRIVE SELECT] to select the drive.

DVD↔VHS

- **Mode** (Recording mode)

**DVD**

XP↔SP↔LP↔EP↔FR (→ 19)

**VHS**

SP↔LP↔EP↔AUTO (→ 19, 25)

You can also press [REC MODE] to change the recording mode.

- **Programme Name**

Press [◀, ▶] to select “Programme Name” and press [ENTER] (→ 52).

**4 Press [ENTER] when you have finished making changes.**

The settings are stored and the programme goes to timer recording standby.

The timer recording icon is displayed in the left column.

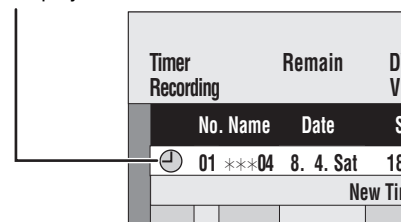

- “⊖” lights on the unit’s display.

- Make sure that the timer recording has been programmed correctly on the timer recording screen (→ 25).

- “Invalid Entry” is displayed when you enter the wrong item.

Re-enter the item.

- To continue programming:

Select “New Timer Programme” and repeat steps 2 to 4.

**The timer recording standby mode is activated.**

**However, the unit may not turn off automatically.**

- If a timer recording starts while the unit is turned on, the unit will not automatically turn off after the timer recording is complete. To save power turn the unit off after the timer recording is complete. To save power turn the unit off by pressing [⊖, DVD/VHS].

You can turn the unit off during timer recording. This will not affect the recording.

**Note**

Refer to “Notes on timer recording” → left.

### ■ Check, change or delete programmes

Even when the unit is turned off, you can display the timer recording list by pressing [PROG/CHECK].

It is also possible to edit the Timer Recording screen while timer recording is performing. However you cannot edit the programme that is currently being recorded.

#### 1 Press [PROG/CHECK].

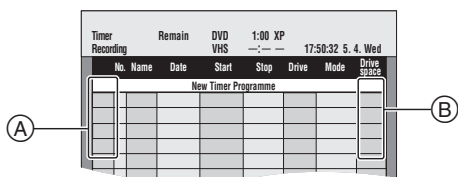

#### Icon explanations (A)

- : Currently recording
- Ⓜ: Programmes are overlapped. Recording of the programme with the later start time starts when the earlier programme finishes recording.
- ⌚: Timer recording standby is on. The recording will start at the set time.
- ⊖: You stopped a weekly or daily timer recording. The icon disappears when the next timer recording starts.
- F: The disc was full (not enough space).
- Ⓜ: The TV programme may not be recorded due to copy-protect. **DVD**
- ✘: Recording stopped. (Dirty disc or video cassette, etc.)

#### Check (B)

- OK:** Recordable. **DVD**
- **(Date):** The last day of daily or weekly recording. **DVD**
- !:
- It may not be possible to record because:
    - The disc is write-protected. **DVD**
    - There is no more space left. **DVD**
    - The number of possible titles has reached its maximum. **DVD**
    - The new timer recording will completely or partially record over this timer recording.
  - The timer recording was not performed or completed for the following reasons:
    - A disc or a video cassette was not inserted.
    - A disc or a video cassette without a secure accidental erasure prevention tab was inserted.
    - The remaining recording time on the video cassette was insufficient. **VHS**
  - : All other recordable cases. **VHS**

#### 2 Press [▲, ▼] to select the programme.

- You can also select the programme by inputting a 2-digit number using the numbered buttons.

e.g., "5": [0]→[5]  
 "15": [1]→[5]

- Press [◀, ▶] to move to the preceding or following page.

#### 3 Press [\*] to delete or press [ENTER] to change.

- You cannot delete or change the programme that is currently being recorded.

#### 4 If you pressed [ENTER] in step 3, Press [▲, ▼, ◀, ▶] to change the settings and then press [ENTER].

To continue changing the programmes repeat steps 2 to 4.

#### 5 Press [RETURN].

The timer recording standby mode is activated.

However, the unit will not be turned off automatically.

- If a timer recording starts while the unit is turned on, the unit will not automatically turn off after the timer recording is complete. To save power turn the unit off by pressing [⏻, DVD/VHS].

You can turn the unit off during timer recording. This will not affect the recording.

#### For your reference

- Programmes that failed to record are deleted from the timer recording list at 4 a.m. 2 days later.

### ■ Cancel a timer recording that has already begun

#### 1 Press [DRIVE SELECT] to select the drive currently recording and then press [■, STOP].

- A confirmation screen appears.

#### 2 Press [◀] to select "Stop Recording" and then press [ENTER].

- The recording stops and the timer recording programme is deleted from the Timer Recording screen. (Daily and weekly timer recordings are not deleted and timer recording will start as set.)

### ■ Release programme from standby

Each programme in the Timer Recording screen can be released from recording standby.

#### 1 Press [PROG/CHECK].

#### 2 Press [▲, ▼] to select the programme.

#### 3 Press [SUB MENU], press [▲, ▼] to select "Timer Off" and then press [ENTER].

- It is also possible to press [A] to release recording standby. The Timer Recording icon disappears.

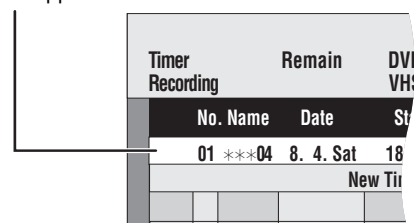

- Be sure to repeat these steps and select "Timer On" in step 3 or press [A] in step 3 before the set recording time to put the programme on recording standby. The timer recording will only work if the programme is in recording standby and the timer icon is displayed.

### ■ Auto SP/LP mode

#### VHS

If, at the beginning of a timer recording, there is not enough tape remaining to complete the recording, the Auto SP/LP function will automatically run the tape at LP speed for recording. This ensures that the entire programme will be recorded. If LP mode is not enough to stretch the remaining tape to fit the whole programme you will not be able to record the whole TV programme.

Timer recording

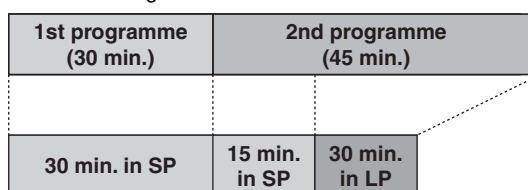

Video cassette (e.g., 60-minute cassette)

- It is not possible to automatically activate EP mode.
- The tape length must be set correctly. (→ 59)
- This may not work correctly with some video cassettes.
- It may not work correctly when NTSC is set as the "TV System". (→ 59)
- If the recording mode changes from SP to LP during a timer recording, some picture distortion occurs at that point.

# Playing discs

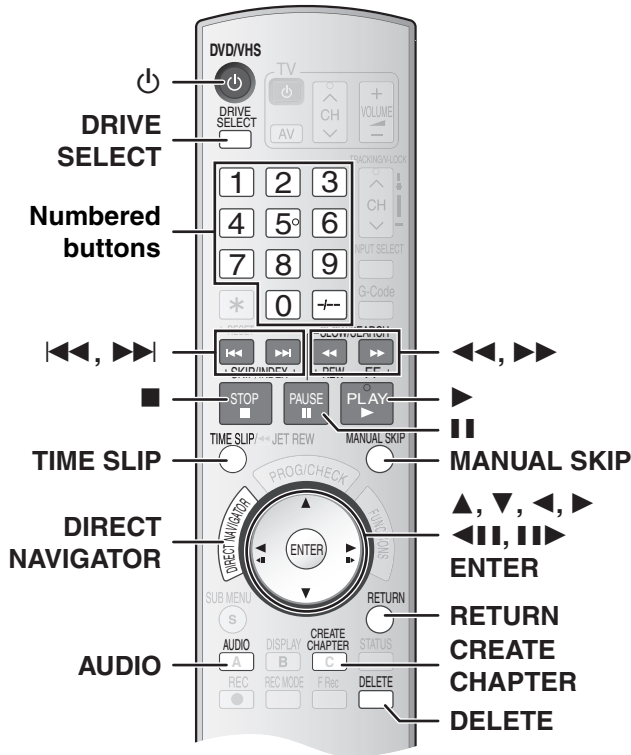

## Preparation

- Select the unit viewing channel (e.g. AV input) on the TV.

## Playing discs

RAM -R -R DL -RW(V) +R +R DL +RW DVD-A DVD-V  
-RW(VR) VCD CD

- 1 Press [⏻, DVD/VHS] to turn the unit on.
- 2 Insert a disc. (→ 17)
- 3 Press [DRIVE SELECT] to select the DVD drive.
- 4 Press [▶, PLAY].

- The disc tray closes and play begins. (The unit takes some time to read the disc before play starts.)
- **RAM -R -R DL -RW(V) +R +R DL +RW -RW(VR)** Playback starts from the most recently recorded title.
- **DVD-A DVD-V VCD CD** Playback starts from the beginning of the disc.

### To stop play

Press [■, STOP].

- **DVD-A DVD-V VCD CD** The screen saver on the right may appear when you stop play. Press [■, STOP] again and you can use the unit's tuner to watch TV. The unit memorizes the position.

### Resume play function

Press [▶, PLAY] to resume play from this position.

- **VCD** Depending on the disc, the resume play function may not be effective.

### To cancel the resume play function

Press [■, STOP] several times to clear the position.

- The position is cleared when the tray is opened.
- **DVD-A VCD CD** MP3 and DivX: The position is cleared when the unit is turned off.

### To pause play

Press [⏸, PAUSE]. (Press again to resume play.)

### Notes

- **RAM -R -R DL -RW(V) +R +R DL +RW -RW(VR)** The unit stops playing the disc when timer recording starts.
- **RAM** Press [▶, PLAY] when you wish to start playing the disc while recording (→ 21, Chasing play).

## When a menu screen appears on the TV

### VCD

Press the numbered buttons to select an item.

e.g.: "5": [0]→[5]  
"15": [1]→[5]

### DVD-A DVD-V

Press [▲, ▼, ◀, ▶] to select an item and press [ENTER].

- You can sometimes use the numbered buttons to select an item.

### Other buttons used to operate menus

Read the disc's instructions for further details about operation.

### Note

- If "⊘" appears on the TV, the operation is prohibited by the unit or disc.

## Selecting recorded titles to play

RAM -R -R DL -RW(V) +R +R DL +RW -RW(VR)

- 1 Press [DIRECT NAVIGATOR].

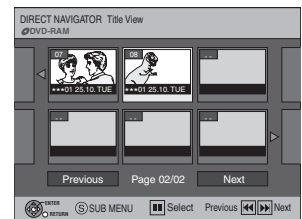

- 2 Press [▲, ▼, ◀, ▶] to select the title you want to watch and then press [ENTER].

- Play starts.
- You can also select titles by entering a 2-digit number with the numbered buttons.  
e.g.: "5": [0]→[5]  
"15": [1]→[5]
- If you enter a number larger than the total number of titles, the last title is selected.
- Press [◀◀, SKIP] or [▶▶, SKIP] to show other pages.

### To stop play

Press [■, STOP]. (The Title View screen appears.)

### To exit the screen

Press [RETURN].

### For your reference

- Direct Navigator screen icons

- 🔒: Title protected
- 🔒: Copy-protected so it was not recorded.
- ✕: Unable to play
- : Currently recording
- 📀: Title with "One time only recording" restriction (→ 62, CPRM)
- 📺: NTSC/📺: PAL
  - Title recorded using a different encoding system from that of the TV system currently selected on the unit.

## Quick View (Play ×1.3)

### RAM

The play speed can be increased without distorting the audio.

### During Play

Press and hold [▶, PLAY].



### To return to normal speed

Press [▶, PLAY].

## Manual Skip

RAM -R -R DL -RW(V) +R +R DL +RW -RW(VR)

Press [MANUAL SKIP].

Each time you press [MANUAL SKIP], play restarts approximately 30 seconds later.



## Fast forward and rewind — SEARCH

RAM -R -R DL -RW(V) +R +R DL +RW DVD-A DVD-V  
-RW(VR) VCD CD

### During Play

Press [**◀◀**, SLOW/SEARCH] or [**▶▶**, SLOW/SEARCH].

- There are 5 search speeds. Each press increases the search speed.  
(+R +R DL +RW Up to 3 speeds)
- Press [**▶**, PLAY] to restart playback.
- DivX: Audio is not heard during search.



### For your reference

- Sound is output only in the first level of fast forward. However, with DVD-Audio (except motion picture parts), CD and MP3, it is output in all levels.
- Depending on the disc, search may not be possible.

## Skipping

RAM -R -R DL -RW(V) +R +R DL +RW DVD-A DVD-V  
-RW(VR) VCD CD

### During play or while paused

Press [**◀◀**, SKIP] or [**▶▶**, SKIP].

- Each press increases the number of skips.
- DivX: Backward [**◀◀**, SKIP] only.

## Slow-motion play

RAM -R -R DL -RW(V) +R +R DL +RW  
DVD-A (Motion picture parts only) DVD-V -RW(VR) VCD

### While paused

Press [**◀◀**, SLOW/SEARCH] or [**▶▶**, SLOW/SEARCH].

- When slow-motion play is continued for about 5 minutes it pauses automatically (excluding DVD-A DVD-V VCD).
- There are 5 play speeds. Each press increases the play speed.
- Press [**▶**, PLAY] to restart playback.
- VCD Forward direction [**▶▶**, SLOW/SEARCH] only.

## Frame-by-frame viewing

RAM -R -R DL -RW(V) +R +R DL +RW  
DVD-A (Motion picture parts only) DVD-V -RW(VR) VCD

### While paused

Press [**◀|||**] ([**◀**]) or [**|||▶**] ([**▶**]).

- Each press shows the next or previous frame.
- Press and hold to change in succession forward or backward.
- Press [**▶**, PLAY] to restart playback.
- VCD Forward direction [**|||▶**] ([**▶**]) only.

## Direct play

RAM -R -R DL -RW(V) +R +R DL +RW DVD-A DVD-V  
-RW(VR) VCD CD

You can play from the title, chapter or track you select.

### During Play

Press the numbered buttons to select an item.

CD (MP3, JPEG and TIFF disc only)

e.g.: "5": [0]→[5] "5": [0]→[0]→[0]→[5]  
"15": [1]→[5] "15": [0]→[0]→[1]→[5]

### DVD-A

A group number can be specified while the screen saver (→ 26) is displayed.

e.g.: "5": [5]

- With some discs, this only works when stopped (screen saver is displayed).

### Playing bonus groups

Some discs contain bonus groups. If a password screen appears after selecting a group, enter the password with the numbered buttons and press [ENTER]. For the password, refer to the disc's jacket, etc.

## Deleting a title that is being played

RAM -R -R DL -RW(V) +R +R DL +RW

Once a title is deleted, it cannot be restored. Make certain before proceeding.

- 1 During Play Press [DELETE].
- 2 Press [**◀**] to select "Delete" and press [ENTER].

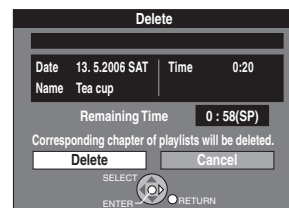

### For your reference

- You cannot delete while recording or transferring (copying).
- The disc's available recording time may not increase after deleting short titles.
- -R -R DL +R +R DL Available space does not increase after deleting.
- -RW(V) +RW Available space increases when the title recorded last is deleted. (The recording space may increase slightly when other titles are deleted.)

## Select an amount of time to skip — Time Slip

RAM -R -R DL -RW(V) +R +R DL +RW -RW(VR)

- 1 During play Press [TIME SLIP].
- 2 While observing the time indicator at the top right Press [**▲**, **▼**] to set an amount of time to skip and press [ENTER].

Play is skipped for the amount of time you specified.

- Each time you press [**▲**, **▼**] the time increases [**▲**] or decreases [**▼**] in 1 minute intervals. (Press and hold for 10-minute intervals)

## Create chapters

RAM

### During play

Press [CREATE CHAPTER].

- Press [**◀◀**, SKIP] or [**▶▶**, SKIP] to skip to the start of a chapter.
- You cannot activate this function when you are carrying out Transfer (Copy) (→ 44).
- It may not be possible to create the new chapter, if the created chapter is going to be extremely short.

## Changing audio during play

Press [AUDIO] to select the audio type.

- Depending on the type of disc and format, the audio that can be selected varies.

RAM -RW(VR) VCD and DivX

LR→L→R  
↑

e.g., RAM  
"L R" is  
selected.

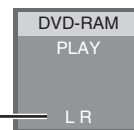

RAM -RW(VR) [When playing a bilingual broadcast recorded on DVD-RAM, DVD-RW (DVD Video Recording format)]  
M1←→M2

DVD-A DVD-V +R +R DL +RW (→ 34)

This allows you to change items like the audio channel number and the soundtrack language.



e.g., DVD-V English is the selected language.

### Note

- If you cannot change the audio type when you are only using an optical digital cable for connection, set "Dolby Digital" to "PCM" (→ 58). Alternatively, you may connect to an amplifier with an Audio/Video cable and change the input on the amplifier to suit the connection.

# Using menus to play DivX, MP3 and still pictures (JPEG/TIFF)

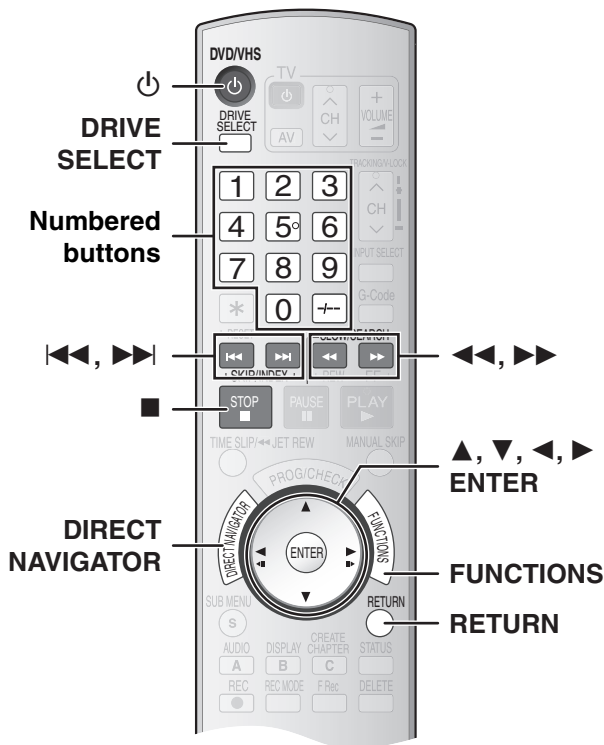

## Preparation

- Press [DRIVE SELECT] to select the DVD.

## Playing discs which contain DivX video contents, MP3 and still pictures

**-R** (Only for DivX) **CD**

You can play DVD-R which contain DivX video contents and CD-R/RW which contain DivX video contents, MP3 and still pictures that have been recorded on a computer.

The screen shown below is displayed when you insert a disc containing DivX video contents, MP3 files and still pictures (JPEG/TIFF).

e.g.,



- Press [ENTER] to play the file type displayed on the screen.
- Follow the steps below when you want to play files other than the one displayed on the screen.

## To select the file type

- 1 Press [RETURN] if the illustration above is displayed.
- 2 Press [FUNCTIONS].

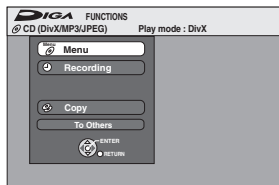

- 3 Press [▲, ▼] to select "Menu" and then press [ENTER].

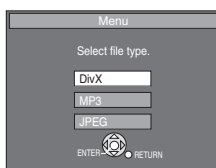

- 4 Press [▲, ▼] to select the playback mode and then press [ENTER].

If "DivX" is selected:

Go to "Playing DivX video contents" step 2, below.

If "MP3" is selected:

Go to "Playing MP3" step 2 on page 29.

If "JPEG" is selected:

Go to "Playing a still picture" step 2 on page 30.

## Playing DivX video contents

**-R** **CD**

You can play DVD-R and CD-R/CD-RW discs which contain DivX video contents that have been recorded on a computer.

- 1 Press [DIRECT NAVIGATOR].

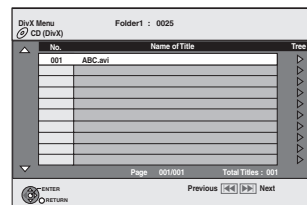

- Files are treated as titles.
- Press [◀◀, SKIP] or [▶▶, SKIP] to show other pages.
- When the MP3 or JPEG Menu is displayed. Follow steps 1 to 4 in "To select file type" on the left column and select "DivX" in step 4 to change the playback mode.

- 2 Press [▲, ▼] to select the title and then press [ENTER].

Play starts on the selected title.

- You can also select a video contents by entering 3-digits with the numbered buttons and then press [ENTER].  
e.g., "5": [0]→[0]→[5] "15": [0]→[1]→[5]

## To stop play

Press [■, STOP].

## To Exit the screen

Press [DIRECT NAVIGATOR].

## Notes

- The picture sizes that were set at the time of recording may prevent the unit from showing pictures in the adequate aspect. You may be able to adjust the aspect through the TV.
- Successive play is not available.

## Using the tree screen to find a folder

- 1 While the file list is displayed Press [▶] while the title is highlighted to display the tree screen.

F: Selected folder no./Total folder no. including DivX title.

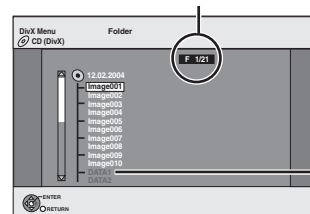

You cannot select folders that contain no compatible files.

- 2 Press [▲, ▼] to select the folder and then press [ENTER].

The file list for the folder appears.

## To return to the previous screen

Press [RETURN].

## About DivX VOD content

DivX Video-on-Demand (VOD) content is encrypted for copyright protection. In order to play DivX VOD content on this unit, you first need to register the unit.

Follow the on line instructions for purchasing DivX VOD content to enter the unit's registration code and register the unit. Visit [www.divx.com/vod](http://www.divx.com/vod) for more information.

### Display the unit's registration code.

(→ 59, "DivX Registration" in the Setup menu.)

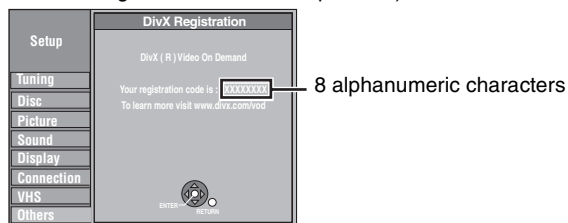

- We recommend that you make a note of this code for future reference.
- After playing DivX VOD content for the first time, another registration code is then displayed in "DivX Registration". Do not use this registration code to purchase DivX VOD content. If you use this code to purchase DivX VOD content and then play the content on this unit, you will no longer be able to play any content that you purchased using the previous code.
- If you purchase DivX VOD content using a registration code different from this unit's code, you will not be able to play this content. ("Authorization Error" is displayed.)

### Regarding DivX content that can only be played a set number of times

Some DivX VOD content can only be played a set number of times. When you play this content, the remaining number of plays is displayed. You cannot play this content when the number of remaining plays is zero. ("Rental Expired" is displayed.)

When playing this content

- The number of remaining plays is reduced by one if
  - you press [⏪, DVD/VHS].
  - you press [■, STOP].
  - you press [⏮, SKIP], [⏮, SLOW/SEARCH] or [⏭, SLOW/SEARCH] etc. and arrive at another content or the start of the content being played.
  - you press [DRIVE SELECT] to change the drive.
- The resume play function does not work.

## Playing MP3

### CD

The unit plays MP3 files recorded on CD-R/RW designed for audio recording that are finalized (→ 62) on a computer. Files are treated as tracks and folders are treated as groups.

#### 1 During stop or play

Press [DIRECT NAVIGATOR].

- The file list appears.

Selected Group No. and Name

G:

The Group Number

T:

Track Number in the Group

TOTAL:

Selected Track Number/  
Total Track Number

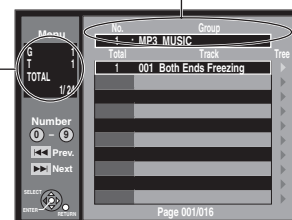

- When the DivX or JPEG menu is displayed, follow steps 1 to 4 in "To select the file type" on page 28 and select "MP3" in step 4.

#### 2 Press [▲, ▼] to select the track and press [ENTER].

- Play starts on the selected track.
- [□] indicates the track currently playing.
- You can also select a track by entering 4-digits with the numbered buttons.  
e.g., "5": [0]→[0]→[0]→[5] "15": [0]→[0]→[1]→[5]

### Using the tree screen to find a group (→ below)

#### To show other groups

Press [◀] (Prev.) or [▶] (Next) to show other pages.

- After listing all the tracks in one group, the list for the next group appears.

#### To exit the file list

Press [DIRECT NAVIGATOR] or [RETURN].

### Using the tree screen to find a group

#### 1 While the file list is displayed

Press [▶] while a track is highlighted to display the tree screen.

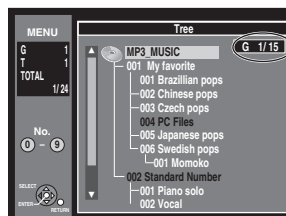

Selected Group Number/Total Group Number

- If the group has no track, "—" is displayed as group number.

- A group (folder) which has no MP3 files is indicated in black. You cannot select groups with no MP3 files.
- Press [◀, ▶] to jump layers in the tree screen.

#### 2 Press [▲, ▼] to select a group and press [ENTER].

- The file list of the selected group appears.

#### To return to the file list

Press [RETURN].

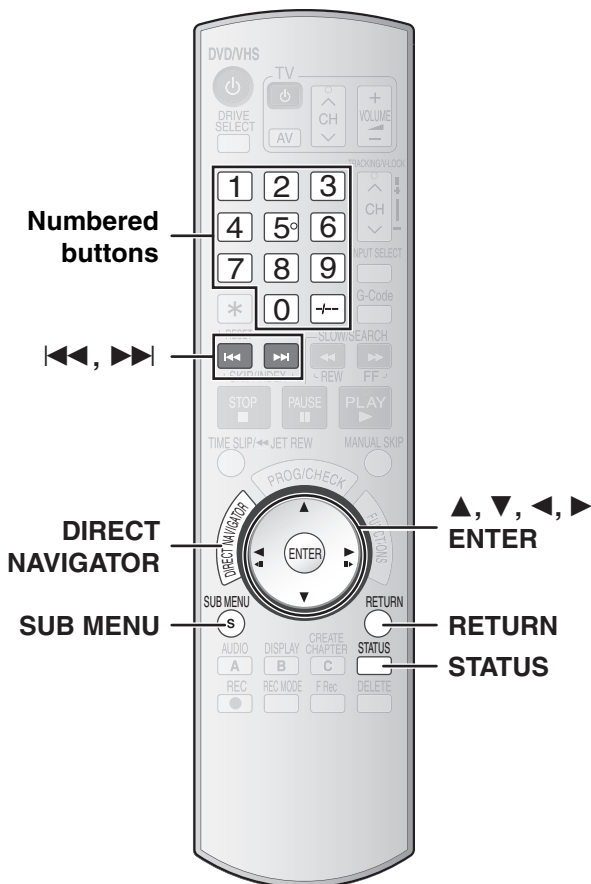

## Playing a still picture

**CD**

The unit plays still pictures (JPEG/TIFF) files recorded on CD-R/RW that are finalized (→ 62) on a computer. Files are treated as pictures and folders are treated as albums.

### 1 Press [DIRECT NAVIGATOR].

When the DivX or MP3 menu is displayed, follow steps 1 to 4 in "To select the file type" on page 28 and select "JPEG" in step 4.

#### To show other pages

Press [◀] (Previous) or [▶] (Next) to show other pages.

- You can also press [▲, ▼, ◀, ▶] to select "Previous" or "Next" and then press [ENTER] to show other pages.
- Press [DIRECT NAVIGATOR] or [RETURN] to exit the JPEG menu.

### 2 Press [▲, ▼, ◀, ▶] to select a still picture you want to watch and then press [ENTER].

- You can also select a still picture by entering 4-digits with the numbered buttons.

e.g.: "5": [0]→[0]→[0]→[5] "15": [0]→[0]→[1]→[5]

- You can watch the still pictures in order by pressing [◀] (previous) or [▶] (next).

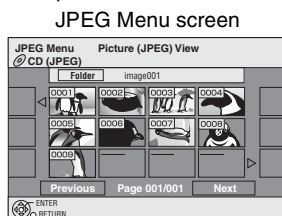

### To rotate a still picture

#### 1 Press [SUB MENU].

#### 2 Press [▲, ▼] to select "Rotate RIGHT" or "Rotate LEFT" and then press [ENTER].

- The rotation information will not be stored:
  - [CD] Still pictures
  - When the disc is protected.
  - When played on other equipment.
  - When copying pictures.

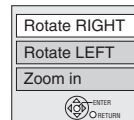

### To zoom in/out

#### 1 Press [SUB MENU].

#### 2 Press [▲, ▼] to select "Zoom in" and then press [ENTER].

- To return the picture to its original size repeat step 1 and then press [▲, ▼] to select "Zoom out" in step 2 and then press [ENTER].
- The still picture may be cut off when zooming in.
- The enlargement information will not be stored.
- The "Zoom in"/"Zoom out" function is only effective with still pictures smaller than 640×480 pixels.

### To show the picture properties

#### 1 Press [STATUS] twice.

- Press [STATUS] again and the properties disappear.

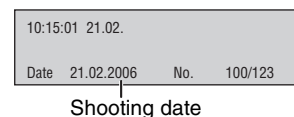

## Start Slide Show/Slide Interval

- Display the JPEG Menu screen by following the steps in "Playing a still picture". (→ Left)

You can display still pictures one by one with a regular interval.

### 1 Press [▲] to select "Folder" and then press [SUB MENU].

### 2 Press [▲, ▼] to select "Start Slide Show" and then press [ENTER].

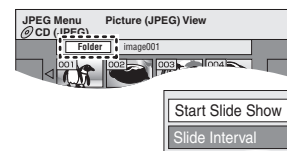

### To Change the length of the interval

- 1 Press [▲, ▼] to select "Slide Interval" in step 2 (→ Above) and then press [ENTER].
- 2 Press [◀, ▶] to select the desired length (0 to 30 seconds) and then press [ENTER].

## To select still pictures in another folder

- Display the JPEG Menu screen by following the steps in "Playing a still picture". (→ Left)

You can display still pictures one by one with a regular interval.

### 1 Press [▲] to select "Folder" and then press [ENTER].

### 2 Press [▲, ▼] to select the folder and then press [ENTER].

- Ⓐ Selected folder no./Total folder no.
- Ⓑ You cannot select folders that contain no compatible files.

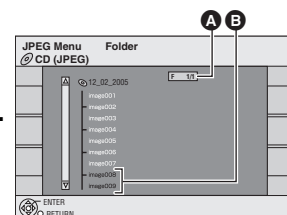

### To return to the file list

Press [RETURN].

**Regarding DivX video contents, MP3 and still pictures (JPEG/TIFF)**

- Compatible formats: ISO9660 level 1 or 2 (except for extended formats) and Joliet
- This unit is compatible with multi-session but reading or play of the disc may take time if there are a lot of sessions.
- Operation may take time to complete when there are many files (tracks) and/or folders (groups) and some files (tracks) may not display or be playable.
- The English alphabet and Arabic numbers are displayed correctly. Other characters may not be displayed correctly.
- The display order on this unit may differ from how the order is displayed on a computer.
- Depending on how you create the disc (writing software), files (tracks) and folders (groups) may not play in the order you numbered them.
- This unit is not compatible with packet-write format.
- Depending on the recording, some items may not be playable.

- You can play MP3 and still pictures (JPEG/TIFF) on this unit by making folders as shown below. However depending on how you create the disc (writing software), play may not be in the order you numbered the folders.
- When the highest level folders are "DCIM" folders, they are displayed first on the tree.

**Structure of MP3 folders**

Prefix with 4-digit numbers in the order you want to play them.

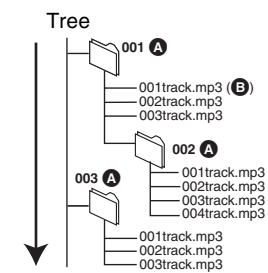

Order of play

- A** Folder = Group
- B** File = Track
- C** Folder

**Structure of still pictures (JPEG/TIFF)**

Files inside a folder are displayed in the order they were updated or taken.

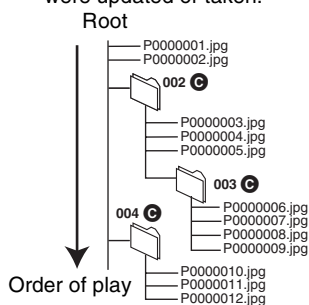

Order of play

**DivX\*1**

Playable discs	<b>-R CD</b>
File format	DivX • Files must have the extension ".DIVX", ".divx", ".AVI" or ".avi".
Maximum number of folders	300 (including the root folder)
Maximum number of files	200*2
Supported version	DivX ver.2.11, 4.x, 5.x Video - Number of streams: 1 - Codec: DIV3, DIV4, DIVX, DV50 - Picture size: 32 × 32 to 720 × 576 - FPS (Frames Per Second): Up to 30 fps Audio - Number of streams: Up to 8 - Format: MP3, Dolby Digital (AC3), MPEG - Multi channel: Dolby Digital (AC3) is possible, MPEG multi is 2 ch conversion.

**MP3\*3**

Playable discs	<b>CD</b>
File format	MP3 • Files must have the extension ".mp3" or ".MP3".
Maximum number of folders	300 (including the root folder)
Maximum number of files	3000*2
Bit rate	32 kbps to 320 kbps
Sampling frequency	16 kHz/22.05 kHz/24 kHz/32 kHz/44.1 kHz/48 kHz

**Still pictures (JPEG/TIFF)\*4\*5**

Playable discs	<b>CD</b>
File format	JPEG, TIFF*4 (non-compressed RGB chunky format) • Files must have the extension ".jpg", ".JPG", ".tif" or ".TIF"
Number of pixels	34 × 34 to 6144 × 4096 (Sub sampling is 4:2:2 or 4:2:0)
Maximum number of folders	300 (including the root folder)
Maximum number of files	3000*2

\*1 GMC (Global Motion Compensation) is not supported.

\*2 The total number of recognizable DivX, MP3, JPEG and other types of files is 4000.

\*3 This unit is not compatible with ID3 tags.

\*4 The operation may take more time to complete when playing TIFF format still pictures.

\*5 Motion JPEG is not supported.



# Playing a video cassette

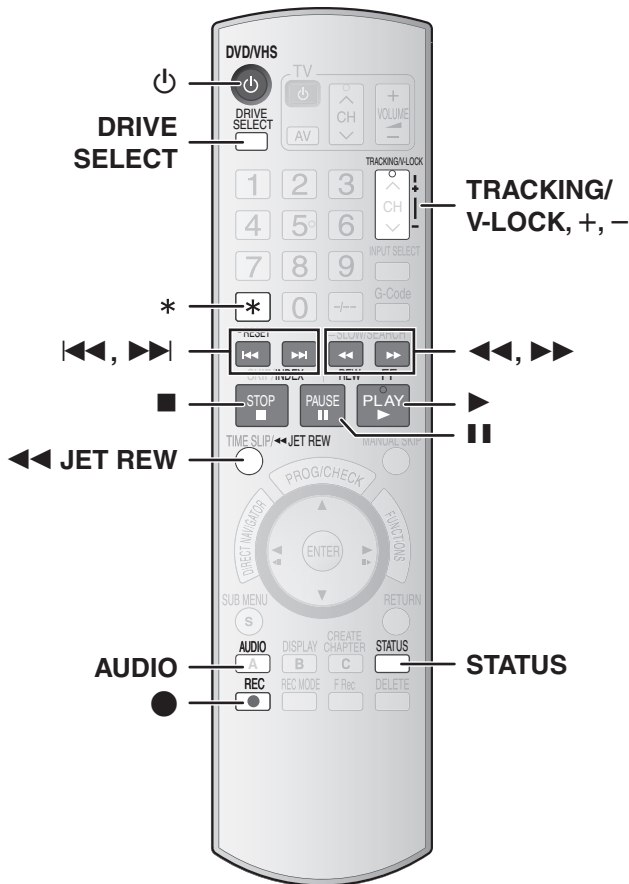

## Preparation

- Select the unit viewing channel (e.g. AV input) on the TV.
- Press [⏻, DVD/VHS] to turn the unit on.
- Press [DRIVE SELECT] to select the VHS.

## 1 Insert a recorded video cassette. (→ 17)

- Play starts automatically if you insert a video cassette without the accidental erasure prevention tab.

## 2 Press [▶, PLAY].

### ■ To pause play

Press [⏸, PAUSE]. (Press again, to restart play.)

### ■ To stop play

Press [■, STOP].

### Notes

- If the unit is on standby with the VHS selected, an inserted video cassette can be played back by pressing [▶, PLAY].
- When the tape reaches its end, the unit automatically rewinds it to the beginning. This function does not work during timer recording and fast-forwarding.
- Jet Search, cue, review or slow-motion play will be automatically cancelled after 10 minutes and pause play will be automatically cancelled after 5 minutes
- During playback functions other than normal playback, horizontal noise bars may appear on the picture, the colour of the picture may be unstable or the picture may be otherwise distorted.
- When playing back a video cassette which was recorded on another VCR, it may be necessary to adjust the tracking (→ 33). In some cases the picture quality may still be inferior. This is due to format constraints.

## Fast-forward/Rewind

### While stopped

Press [◀◀, REW] (backward)/[▶▶, FF] (forward).

- Press [■, STOP] to stop fast-forward/Rewind.

## Cue/Review

### During play

Press or press and hold [◀◀, REW] (backward)/[▶▶, FF] (forward).

- Press [▶, PLAY] to restart normal playback.
- If you press and hold these buttons, normal playback restarts by releasing them.

## Jet Search

### During play

Press [◀◀, REW] (backward)/[▶▶, FF] (forward) twice. You can increase Cue/Review search speed.

- Press [▶, PLAY] to restart normal playback.
- The picture may not be in colour or the picture may be distorted depending on the TV.

## Slow-motion play

### During play

Press and hold [⏸, PAUSE] for about 2 seconds or more.

- Press [▶, PLAY] to restart normal playback.

## Jet Rewind

### To perform a higher speed rewind

Press [◀◀ JET REW].

The "◀◀" indication appears on the TV screen and "JETREW" appears on the unit's display.

- Depending on the video cassette or the operating condition, the rewind speed may change somewhat.
- The tape counter is reset to "0:00.00" when the tape is rewound to the beginning.
- Depending on the video cassettes, this function may not work.

## S-VHS Quasi Playback (SQPB)

It is also possible to play back video cassettes recorded in the S-VHS system.

- Some picture noise may occur depending on the type of video cassette used.
- It is not possible to fully obtain the high resolution that S-VHS is capable of.
- It is not possible to record in the S-VHS system with the unit.

## Repeat Playback

### During play or while stopped

Press and hold [▶, PLAY] for about 5 seconds or more.

- At the end of the programme the tape automatically rewinds to the beginning of the programme and play starts again (it only works if there is at least 5 seconds of blank space at the end of the programme). This continues until you cancel it.
- Depending on the video cassette, this function may not work.

### ■ To restart normal playback

Press [▶, PLAY].

### ■ To stop play

Press [■, STOP].



## Adjusting the playback picture

### Manual tracking

The unit usually makes tracking adjustments automatically, but you may need to adjust it manually if noise appears on a video cassette recorded on other equipment.

#### During play

**Press and hold [TRACKING/V-LOCK, +] or [TRACKING/V-LOCK, -] until the noise bars disappear.**

- If the noise bars appear during still playback, start slow-motion play and then adjust the tracking.

### Vertical locking adjustment

If the still picture shakes, perform the following operation.

#### While paused

**Press and hold [TRACKING/V-LOCK, +] or [TRACKING/V-LOCK, -] until the picture stops shaking.**

### To return to auto tracking

Press both [TRACKING/V-LOCK, +] and [TRACKING/V-LOCK, -] simultaneously.

### To remove the noise from a paused picture

Start Slow-motion play, then adjust the tracking.

#### Notes

- This function may not work with some TVs and video cassettes.
- You can also adjust the tracking and vertical synchronization with [CH, v] and [CH, ^] on the main unit.

## VHS Index Search System (VISS)

The unit automatically records special index signals onto the tape every time a recording is started. The index search function makes use of these index signals to let you find the beginning of a desired programme quickly and easily.

### Index signals are recorded in the following cases.

- When a recording is started by pressing [●, REC].
- When timer recording is started.

#### While stopped or during normal play

**Press [◀◀, INDEX] or [▶▶, INDEX].**

- The unit automatically starts playback after the index signal is found.
- Each press increases the number of skips.



### To cancel the index search

Press [■, STOP].

#### Notes

- Up to 20 index signals can be searched for in both directions.
- When you press either of the buttons too much, you can correct the number of skips by pressing the opposite button.
- The figure on the display decreases by 1 each time an index signal is located.
- This feature may not work correctly if the index signals are too close together. Make recordings of at least 5 minutes.

## Changing audio during play

**Press [AUDIO] to select the audio type.**

The audio changes as follows:

L R (Stereo) → L → R → No display (Normal audio track)

## Various indications in on-screen display

When playing back VHS, the on-screen displays that are illustrated below can be displayed.

To see these displays, set the "On-Screen Messages" item in the Display menu in Setup to "Automatic" (→ 58).

**Press [STATUS].**

The following displays appear.

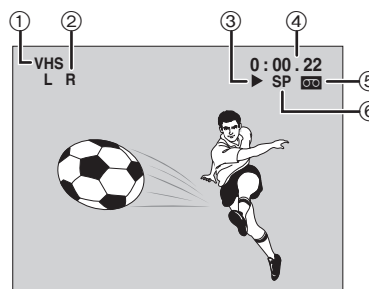

①	<b>Currently selected drive</b>
②	<b>Audio indicators</b> The Left (L) and Right (R) indicators show which sound mode is selected as follows: L R (Stereo): Both the L and R indicators appear. L: The L indicator appears. R: The R indicator appears.
③	<b>Operation status display</b> <b>Tape running display</b> Pressing [STATUS] once makes the on-screen display appear. After that, press the button repeatedly to change the display as follows: No display → Tape counter → Remaining tape time
④	<ul style="list-style-type: none"> <li>• Press [*, RESET] to reset the tape counter (elapsed time) to "0:00.00". The tape counter is automatically reset to "0:00.00" when inserting a video cassette.</li> <li>• The remaining time is approximate. It will be incorrect if you set the wrong tape time in the "Tape length" item in the "Setup" menu and if the tape is of poor quality.</li> </ul>
⑤	<b>Tape indicator</b> Displayed when a video cassette is inserted.
⑥	<b>Recording mode</b>

#### Note

- The on-screen display may be distorted depending on the video cassette being played back or the input signal.

## Using DISPLAY menus



### Common procedures

RAM -R -R DL -RW(V) +R +R DL +RW DVD-A DVD-V  
-RW(VR) VCD CD

#### Preparation

- Press [DRIVE SELECT] to select the DVD.

#### 1 Press [DISPLAY].

Disc	Soundtrack	1	DD Digital 2/0ch
Play	Subtitle		Off
Picture	Audio channel		L R
Sound			
Other			

Menu                      Item                      Setting

#### 2 Press [▲, ▼] to select a menu and then press [▶].

#### 3 Press [▲, ▼] to select an item and then press [▶].

#### 4 Press [▲, ▼] to select a setting.

- Different operations are required depending on settings. Follow the on-screen instructions.

### To exit the screen

Press [DISPLAY].

#### For your reference

- The screens depend on the disc contents.
- Depending on the condition of the unit (playing, stopped, etc.) and the type of software you are playing, there are some items that you cannot select or change.

### ▶ Disc menu

RAM -R -R DL -RW(V) +R +R DL +RW DVD-A DVD-V  
-RW(VR) VCD

Disc	Soundtrack	1	DD Digital 2/0ch
Play	Subtitle		Off
Picture	Audio channel		L R
Sound			
Other			

#### Soundtrack

RAM -R -R DL -RW(V) +R +R DL +RW -RW(VR)

The disc's audio attributes appear. (See (B) Audio attributes)

DVD-A DVD-V

Select the audio and language. (See (A) Soundtrack/Subtitle language, (B) Audio attributes)

DivX

Select the soundtrack number.

- Soundtrack numbers are displayed even when there is only one audio type.

#### Subtitle

DVD-A DVD-V +R +R DL +RW

Turn the subtitle on/off and select the language (See (A) Soundtrack/Subtitle language)

RAM -R -R DL -RW(V) -RW(VR) (Only discs that contain subtitle on/off information)

Turn the subtitle on/off.

- Subtitle on/off information cannot be recorded using this unit.

DivX

Turn the subtitle on/off and select the subtitle number.

#### Audio channel RAM -RW(VR) VCD and DivX

→ 27, Changing audio during play

#### Source select (DivX only)

When you select "Automatic" the constructing method of the DivX contents is automatically distinguished and output. If the picture is distorted, select "Progressive" or "Interlace" depending on which method was used when the contents were recorded to the disc.

- Automatic
- Progressive
- Interlace

#### Angle DVD-A DVD-V +R +R DL +RW

Change the number to select an angle.

#### STILL-P (Still picture) DVD-A

Selects the play method for still pictures.

**Slide Show:** Plays according to the default order on the disc.

**Page:** Select the still picture number and play.

**RANDOM:** Plays in random order.

**Return:** Returns to the default still picture on the disc.

#### PBC (Playback control) VCD (→ 62)

Indicates whether menu play (playback control) is On or Off. (Unchangeable)

#### (A) Soundtrack/Subtitle language

ENG: English	DAN: Danish	THA: Thai
FRA: French	POR: Portuguese	POL: Polish
DEU: German	RUS: Russian	CES: Czech
ITA: Italian	JPN: Japanese	SLK: Slovak
ESP: Spanish	CHI: Chinese	HUN: Hungarian
NLD: Dutch	KOR: Korean	FIN: Finnish
SVE: Swedish	MAL: Malay	*: Others
NOR: Norwegian	VIE: Vietnamese	

#### (B) Audio attributes

LPCM/PPCM/DD Digital/DTS/MPEG: Signal type

k (kHz): Sampling frequency

b (bit): Number of bits

ch (channel): Number of channels

#### For your reference

- The display changes according to the disc content. You cannot make a change when there is no recording. Some discs only allow changes to soundtracks, subtitles and angles by using the disc's setup menus (→ 26)

► **Play menu**

RAM -R -R DL -RW(V) +R +R DL +RW DVD-A DVD-V  
-RW(VR) VCD CD



**Repeat Play**

This function only works when the elapsed play time is displayed. Select the item for repeat play. Depending on the disc, the items that can be selected will differ.  
● Select "Off" to cancel.

RAM -R -R DL -RW(V) +R +R DL +RW DVD-V -RW(VR)  
Title↔Chapter↔Off

VCD CD (excluding MP3 discs)  
Track↔All↔Off

DVD-A CD (MP3 discs only)  
Track↔Group↔Off

While playing a playlist  
RAM -RW(VR)  
PL (playlist)↔Off

► **Picture menu**



RAM -R -R DL -RW(V) +R +R DL +RW DVD-A DVD-V  
-RW(VR) VCD and DivX

**Playback NR**

Reduces noise and picture degradation.  
On↔Off

RAM -R -R DL -RW(V) +R +R DL +RW DVD-A DVD-V  
-RW(VR) VCD

\***Progressive** (→ 62)

Select "On" to enable progressive output.  
● Select "Off" if the picture is stretched horizontally.  
On↔Off

\***Transfer** (Only when "Progressive" is set to "On")

Select the method of conversion for progressive output to suit the type of material being played (→ 62, Film and Video).

When the output signal is PAL

**Auto:** Detects 25 frames-per-second film content and appropriately converts it.

**Video:** Select when using "Auto" and the video content is distorted.

**Film:** Select this if the edges of the film contents appear jagged or rough when "Auto" is selected. However, if the video contents is distorted as shown in the illustration on the right, select "Auto"

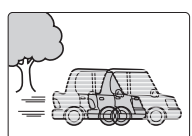

When the output signal is NTSC

**Auto1 (normal):**

Detects 24 frames-per-second film content and appropriately converts it.

**Auto2:** Compatible with 30 frames-per-second film content in addition to 24 frames-per-second film content.

**Video:** Select this when the video contents is distorted while using "Auto1" and "Auto2".

RAM -R -R DL -RW(V) +R +R DL +RW DVD-A DVD-V  
-RW(VR) VCD

**Copy NR** (Only when AV1, AV2 or DV IN is selected)

Reduces video cassette noise during transfer (copy). Depending on the software, jittering may occur.

**Automatic:**

Noise reduction only works on picture input from a video cassette.

**On:** Noise reduction works for any video input.

**Off:** Noise reduction is off. Select when you want to record input as is.

\* Only when you have set "Progressive" to "On" in the Setup menu. (→ 16)

► **Sound menu**

RAM -R -R DL -RW(V) +R +R DL +RW DVD-A DVD-V  
-RW(VR)

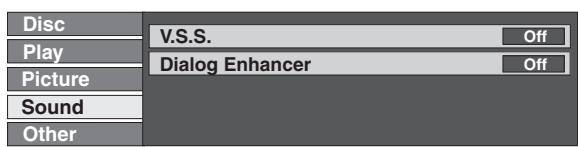

**V.S.S.**

RAM -R -R DL -RW(V) +R +R DL +RW DVD-A DVD-V -RW(VR)  
(Only for Dolby Digital with 2.0 or more channels)

Enjoy a surround-like effect if you are using 2 front speakers (L/R) only.

Natural↔Emphasis↔Off

**Notes**

- Turn V.S.S. off if it causes distortion.
- V.S.S. does not work for bilingual recordings.

**Dialog Enhancer**

RAM -R -R DL -RW(V) +R +R DL +RW DVD-A DVD-V  
-RW(VR) and DivX

(Dolby Digital, 3-channel or over only, including a centre channel)

The volume of the centre channel is raised to make the dialogue easier to hear.

On↔Off

► **Other menu**



**Position**

To change the display position

**1 (Standard) -5:**

The higher the setting the lower the screen moves.

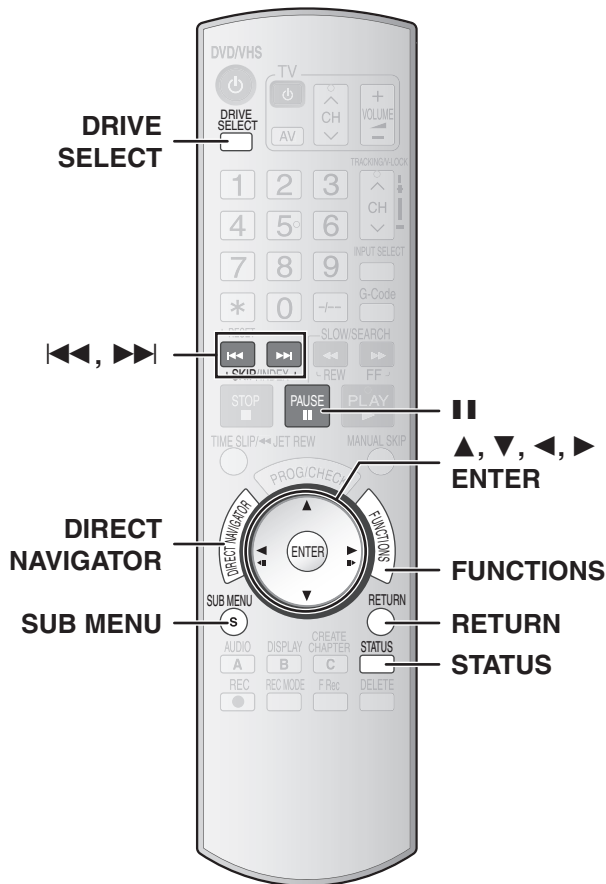

## FUNCTIONS window

By using the FUNCTIONS window you can access the main functions quickly and easily.

- 1 While stopped  
Press [FUNCTIONS].

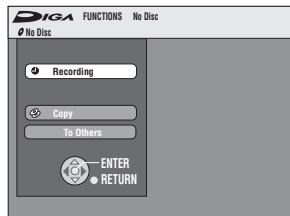

• Functions displayed depend on the type of disc.

- 2 Press [▲, ▼] to select an item and then press [ENTER].
  - If you select "To Others" and press [ENTER], select an item with [▲, ▼] and press [ENTER].

■ To exit the FUNCTIONS window  
Press [FUNCTIONS].

## Status displays

### Changing the information displayed

Status messages appear on the TV screen when operating the unit, to show you what operation was performed and what condition the unit is in.

Press [STATUS] to change the information displayed.

The display changes each time you press the button.  
e.g., **RAM**

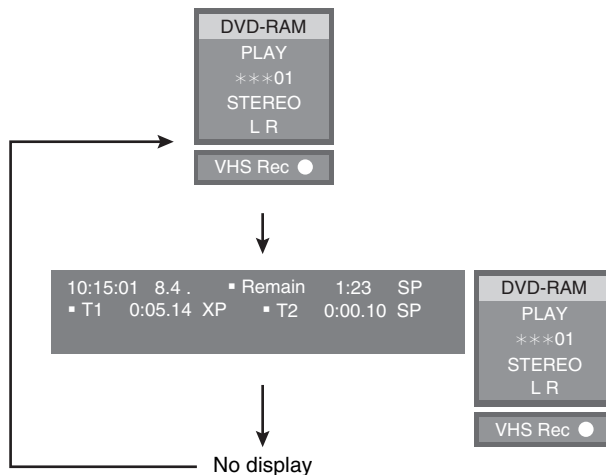

### Display examples

- (1) Current medium
- (2) Current recording or play status, input channel
  - Shows the current state of the unit and the input channel.
  - REC:** Recording
  - PAUSE:** Recording paused
  - PLAY:** Playing
  - PLAY X1.3:** Quick Viewing (Play ×1.3)
  - ||:** Playing paused
  - ▶▶:** Fast forwarding (5 speeds)
  - ◀◀:** Rewinding (5 speeds)
  - ▶▶:** Slow-motion (5 speeds)
  - ◀◀:** Reverse slow-motion (5 speeds)
  - OPEN/CLOSE:** Indicates the status of the disc tray
- (3) TV audio type being received
  - Stereo:** STEREO/NICAM stereo broadcast
  - M1/M2:** Bilingual/NICAM dual-sound broadcast
  - M1:** NICAM monaural broadcast
- (4) Selected audio type (→ 27)
- (5) Other drive mode

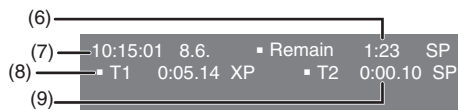
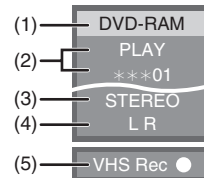

- (6) Available recording time and recording mode  
(e.g.: "1:23 SP" indicates 1 hour and 23 minutes in SP mode)
- (7) The current date and time
- (8) Elapsed play time/Recording mode
- (9) Recording time/Recording mode

## Child Lock

The Child Lock deactivates all buttons on the unit and remote control. Use it to prevent other people from operating the unit.

Simultaneously press and hold [ENTER] and [RETURN] until "X HOLD" appears on the unit's display.

"X HOLD" appears on the display if you press a button while Child Lock is on and the operation is impossible.

### To Cancel the Child Lock

Simultaneously press and hold [ENTER] and [RETURN] until "X HOLD" disappears.

**RAM -R -R DL -RW(V) +R +R DL +RW -RW(VR)**

Press [DIRECT NAVIGATOR] and the list of titles recorded (Title View) is shown. You can play and edit a desired title.

## For your reference

- You cannot edit during recording or transferring (copying), etc.
- +RW** You can create a Top Menu using "Create Top Menu" (→ 55)  
Recording or editing on the disc may delete the menu. If so, create the menu again.
- +R +R DL** Management information is recorded in unused sections when you edit the disc. The available space decreases each time you edit the contents.
- The maximum number of items on a disc:
  - RAM -R -R DL -RW(V)**  
Titles: 99 titles  
Chapters: Approximately 1000
  - +R +R DL +RW**  
Titles: 49 titles  
Chapters: Approximately 254  
(Depends on the state of recording.)

## Title/Chapter

Programmes are recorded as a single title consisting of one chapter.

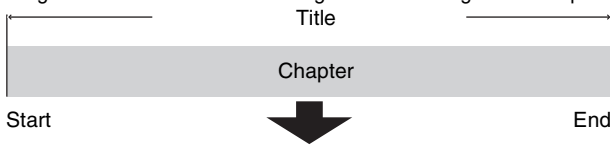

**RAM** You can divide a title into multiple chapters.  
(→ 27, Create chapters, → 39, Create Chapter)

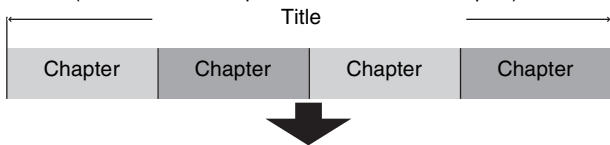

- RAM** You can change the order of chapters and create a playlist (→ 40).
- Titles are divided into about 5 minutes chapters after finalizing (→ 56). **-R -R DL -RW(V)** (8 minutes **+R +R DL**)

## Editing titles with SUB MENU button

### Note

- Once deleted, divided or partially deleted, the title cannot be restored to its original state. Make certain before proceeding.

### Preparation

- RAM** Release protection (disc → 55, cartridge → 55).
- Press [DRIVE SELECT] to select the DVD.

- Press [DIRECT NAVIGATOR].
- Press [**▲**, **▼**, **◀**, **▶**] to select a desired title. e.g., **RAM**
- Press [SUB MENU].
- Press [**▲**, **▼**] to select a desired item and then press [ENTER].
  - After this operation, follow the desired operation.

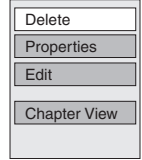

### To return to the previous screen

Press [RETURN].

### To exit the screen

Press [RETURN] several times.

## Title operations

### Delete

**RAM -R -R DL -RW(V) +R +R DL +RW** (Multiple editing → below)

- Follow steps 1 to 3 of "Editing titles with SUB MENU button". (→ Above)

Once deleted, the recorded contents are lost and cannot be restored. Make certain before proceeding.

e.g., **RAM**

- Press [**▲**, **▼**] to select "Delete" and then press [ENTER].
- Press [**◀**] to select "Delete" and then press [ENTER].

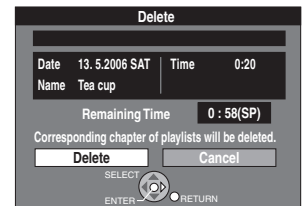

### For your reference

- The disc's available recording time may not increase after deleting short titles.
- The available recording space on DVD-R, DVD-R DL, +R or +R DL does not increase when you delete titles.
- Available recording space on a DVD-RW (DVD-Video format) or +RW increases only when the title recorded last is deleted. The recording space may increase slightly when other titles are deleted.

### Properties

**RAM -R -R DL -RW(V) +R +R DL +RW -RW(VR)**

- Follow steps 1 to 3 of "Editing titles with SUB MENU button". (→ Above)

Title information (e.g., date and time) is shown.

e.g., **RAM**

- Press [**▲**, **▼**] to select "Properties" and then press [ENTER].



### Various operations

#### To show other pages

- Press [**▲**, **▼**, **◀**, **▶**] to select "Previous" or "Next" and press [ENTER].
- You can also press [**◀◀**, SKIP] or [**▶▶**, SKIP] to show other pages.

#### Multiple editing

- Press [**▲**, **▼**, **◀**, **▶**] to select and then press [||, PAUSE]. (Repeat this to select multiple items.)

A check mark appears. Press [||, PAUSE] again to cancel.

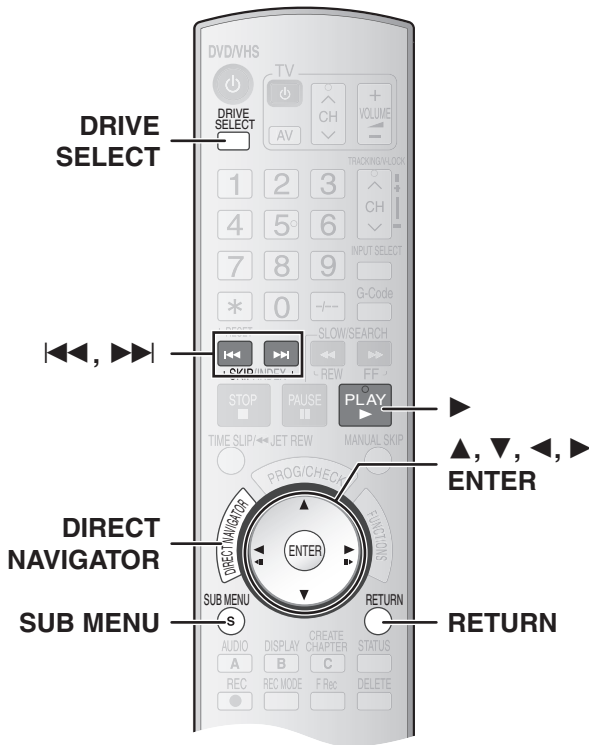

**Edit**

You can perform various kinds of title editing.

**Preparation**

- **RAM** Release protection (disc → 55, cartridge → 55).
- Press [DRIVE SELECT] to select the DVD.

**1** Press [DIRECT NAVIGATOR] and then press [▲, ▼, ◀, ▶] to select a desired title.

- To show other pages → 37
- Multiple editing → 37

**2** Press [SUB MENU].

**3** Press [▲, ▼] to select “Edit” and then press [ENTER].

**4** Press [▲, ▼] to select a desired item and then press [ENTER].

- The editing screen for the selected item appears.

e.g., **RAM**

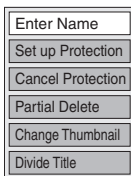

**To return to the previous screen**

Press [RETURN].

**To exit the screen**

Press [RETURN] several times.

**► Enter Name**

**RAM** **-R** **-R DL** **-RW(V)** **+R** **+R DL** **+RW**

- Follow steps 1 to 3 of “Edit”. (→ Above)

**4** Press [▲, ▼] to select “Enter Name” and then press [ENTER].

Refer to “Entering text”. (→ 52)

**► Set up Protection/Cancel Protection**

**RAM** **+R** **+R DL** **+RW** (Multiple editing → 37)

- Follow steps 1 to 3 of “Edit”. (→ Above)

You can prevent accidental erasure of titles by setting and cancelling the write-protection.

**4** Press [▲, ▼] to select “Set up Protection” or “Cancel Protection” and then press [ENTER].

**5** Press [◀] to select “Yes” and then press [ENTER].

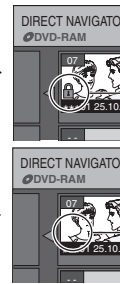
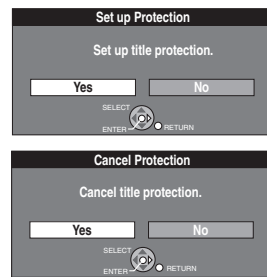

Set up Protection:  
The padlock mark appears.

Cancel Protection:  
The padlock mark disappears.

**For your reference**

Protected titles will be deleted if you format the disc with “DVD Management” (→ 55).

**► Partial Delete**

**RAM**

- Follow steps 1 to 3 of “Edit”. (→ Left)

You can remove unnecessary parts of the title such as commercials.

**4** Press [▲, ▼] to select “Partial Delete” and then press [ENTER].

**5** Press [ENTER] at the start point and end point of the section you want to delete.

- For quicker editing → 39

**6** Press [▲, ▼] to select “Exit” and then press [ENTER].

**7** Press [◀] to select “Delete” and then press [ENTER].

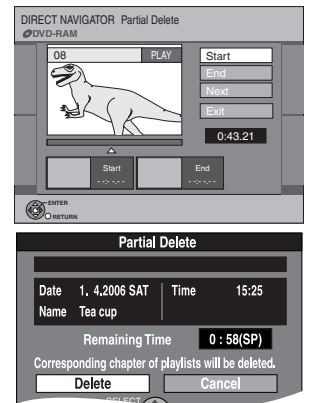

**To delete another part of the same title**

After setting the point of “Start” and “End” in step 5, select “Next” in step 6 and perform step 7, then repeat steps 5 to 7.

**For your reference**

- You may not be able to specify start and end points which are within 3 seconds of each other.
- The disc’s available recording time may not increase after deleting short parts of titles.

**► Change Thumbnail**

**RAM** **-R** **-R DL** **-RW(V)** **+R** **+R DL** **+RW**

- Follow steps 1 to 3 of “Edit”. (→ Left)

You can change the image to be shown as a thumbnail picture in the Title View.

**4** Press [▲, ▼] to select “Change Thumbnail” and then press [ENTER].

**5** Press [▶, PLAY] to play.

**6** Press [ENTER] at the point you want to display.

- For quicker editing → 39
- To change to another point in the same title

- Press [▲, ▼] to select “Change” and press [▶, PLAY] and then repeat step 6.

**7** Press [▲, ▼] to select “Exit” and then press [ENTER].

- The thumbnail picture will be changed at this point.

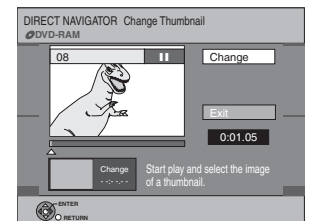



## ▶ Divide Title

### RAM

- Follow steps 1 to 3 of "Edit". (→ 38)

You can divide a selected title into two. The title cannot be restored to its original state. Make certain before proceeding.

- 4 Press [▲, ▼] to select "Divide Title" and then press [ENTER].

- 5 Press [ENTER] at the point you want to divide the title.

- For quicker editing → below
- To change the point to divide
  - Press [▲, ▼] to select "Divide", press [▶, ▶] Play] and then repeat steps 5 to 7.

- 6 Press [▲, ▼] to select "Exit" and then press [ENTER].

- 7 Press [◀] to select "Divide" and then press [ENTER].

- The title is divided at that point.

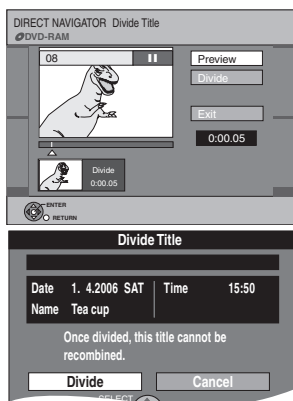

### ■ To check the division point

By selecting "Preview" in step 5 and pressing [ENTER], play will begin from 10 seconds before the division point to 10 seconds after the division point.

### For your reference

- The divided titles retain the name of the original title. They also retain the CPRM property (→ 62) of the original.
- Video and audio just before and after the division point will be momentarily cut out.
- It is not possible to carry out "Divide" in the following cases:
  - When the resulting part(s) are extremely short.
  - When the total number of titles is more than 99.

## Edit Chapters

### Chapter operations

#### Preparation

- RAM Release protection (disc → 55, cartridge → 55).
- Press [DRIVE SELECT] to select the DVD.

### ■ Chapter View

- 1 Press [DIRECT NAVIGATOR] and then press [▲, ▼, ◀, ▶] to select a desired title.

- To show other pages → 37

- 2 Press [SUB MENU].

- 3 Press [▲, ▼] to select "Chapter View" and then press [ENTER].

- 4 Press [▲, ▼, ◀, ▶] to select a desired chapter.

- To start play → Press [ENTER].
- To edit → Follow the steps on the right.

- 5 Press [SUB MENU].

- 6 Press [▲, ▼] to select a desired item and then press [ENTER].

e.g.: RAM

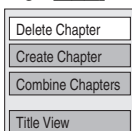

## ▶ Delete Chapter

### RAM (Multiple editing → 37)

- Follow steps 1 to 5 of "Chapter View". (→ Left)

Once deleted, the recorded contents are lost and cannot be restored. Make certain before proceeding.

- 6 Press [▲, ▼] to select "Delete Chapter" and then press [ENTER].

- 7 Press [◀] to select "Delete" and then press [ENTER].

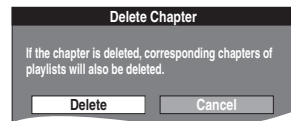

## ▶ Create Chapter

### RAM

- Follow steps 1 to 5 of "Chapter View". (→ Left)

- 6 Press [▲, ▼] to select "Create Chapter" and then press [ENTER].

- 7 Press [ENTER] at the point you want to divide.

- For quicker editing → below
- Repeat this step to divide at other points.



- 8 Press [▲, ▼] to select "Exit" and then press [ENTER].

### For your reference

- The divided titles retain the name of the original title. They also retain the CPRM property (→ 62) of the original.
- Video and audio just before and after the division point will be momentarily cut out.
- It is not possible to carry out "Create Chapter" in the following cases:
  - When the resulting part(s) are extremely short.
  - When the total number of titles is more than 99.

## ▶ Combine Chapters

### RAM

- Follow steps 1 to 5 of "Chapter View". (→ Left)

- 6 Press [▲, ▼] to select "Combine Chapters" and then press [ENTER].

- 7 Press [◀] to select "Combine" and then press [ENTER].

- The selected chapter and the next chapter are combined.

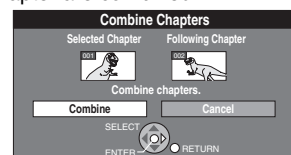

## ▶ Title View

- Follow steps 1 to 5 of "Chapter View". (→ Left)

- 6 Press [▲, ▼] to select "Title View" and then press [ENTER].

You return to the Title View screen.

### ■ To return to the previous screen

Press [RETURN].

### ■ To exit the screen

Press [RETURN] several times.

### For quicker editing

- Use search (→ 27), Time Slip (→ 27) or slow-motion (→ 27) to find the desired point.
- Press [◀◀, SKIP] or [▶▶, SKIP] to skip to the end of a title.

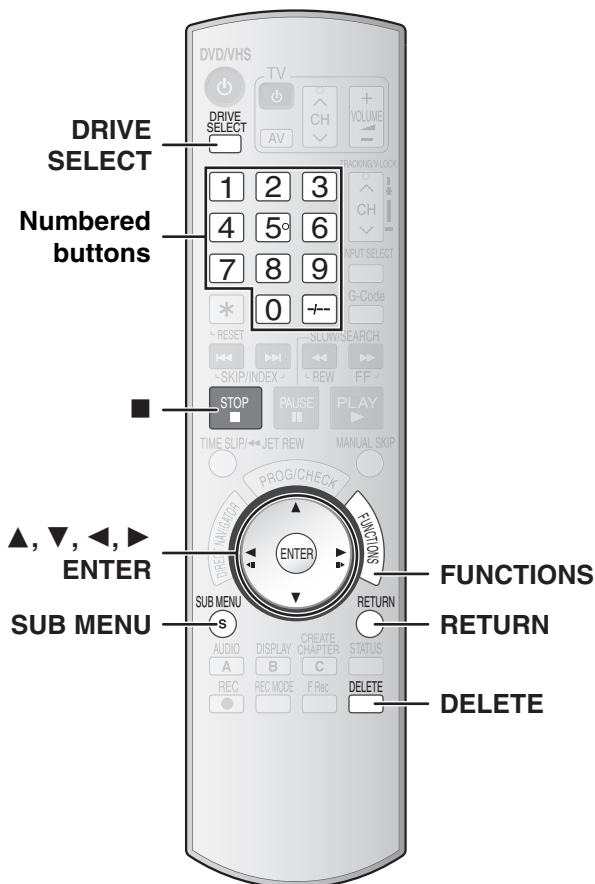

## RAM

You can create a playlist by gathering your favourite chapters from your recordings. You can also play and edit the created playlist.

### Playlist

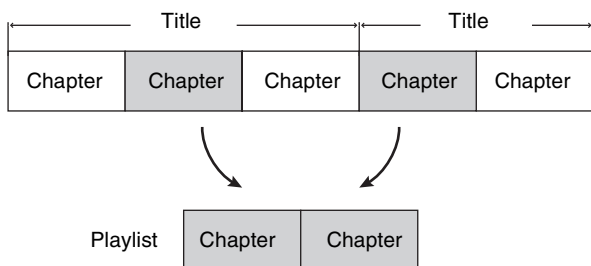

- Editing playlists does not modify titles.
- Playlists are not recorded separately so this does not use much capacity.

- The maximum number of items on a disc:
  - Playlists: 99
  - Chapters in play lists: Approximately 1000 (Depends on the state of recording.)
- If you exceed the maximum numbers of items for a disc, all the items entered will not be recorded.
- You cannot create or edit a playlist while recording.

## Creating playlists

### RAM

#### Preparation

- **RAM** Release protection (disc → 55, cartridge → 55).
- Press [DRIVE SELECT] to select the DVD.

- 1 While stopped Press [FUNCTIONS].
- 2 Press [▲, ▼] to select “To Others” and then press [ENTER].

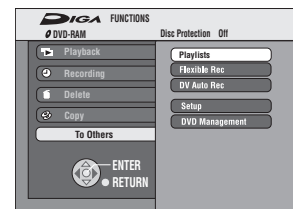

- 3 Press [▲, ▼] to select “Playlists” and then press [ENTER].
  - The Playlist View screen appears.

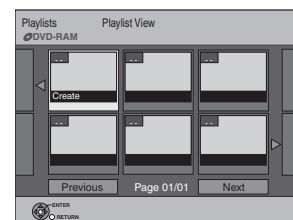

- 4 Press [▲, ▼, ◀, ▶] to select “Create” and then press [ENTER].
- 5 Press [◀, ▶] to select the source title and then press [▼].

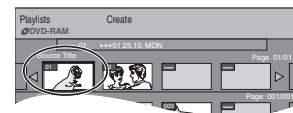

- When you want to select all the chapters in the title, use [◀, ▶] to select the source title and press [ENTER], then skip to step 7.
- Repeat steps 5 to 7 to add other titles or chapters.

- 6 Press [◀, ▶] to select the chapter you want to add to a playlist and then press [ENTER].
  - Press [▲] to cancel.



- You can also create a new chapter in the source title. Press [SUB MENU] to select “Create Chapter” and press [ENTER] (→ 39, Create Chapter).

- 7 Press [◀, ▶] to select the position to insert the chapter and then press [ENTER].



- The chapter is registered in the playlist.
- Repeat steps 6 to 7 to add other chapters.
- To select other source titles, press [▲] several times to return to step 5.

- 8 Press [RETURN].

#### ■ To return to the previous screen

Press [RETURN].

#### ■ To exit the screen

Press [RETURN] several times.

## Playing playlists

**RAM -RW(VR)** (Play only)

### Preparation

- Create playlists. (→ 40)
- Press [DRIVE SELECT] to select the DVD.

- 1 While stopped**  
Press [FUNCTIONS].
- 2 Press [▲, ▼] to select “To Others” and then press [ENTER].**
- 3 Press [▲, ▼] to select “Playlists” and then press [ENTER].**
- 4 Press [▲, ▼, ◀, ▶] to select a playlist and then press [ENTER].**

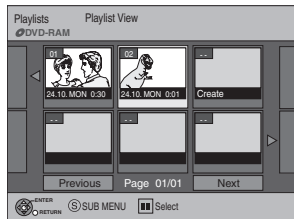

- Playlists are not displayed if you have not created any playlist on the inserted disc.

- You can also select a playlist from the Playlist View screen by entering a 2-digit number with the numbered buttons.

e.g.: “5”: [0]→[5]

“15”: [1]→[5]

- To show other pages → 37

- If you enter a number that is larger than the total number of playlists, “Create” is selected.

### ■ To stop playlist play

Press [■, STOP].

- The Playlist View screen appears.

### ■ To return to the previous screen

Press [RETURN].

### ■ To exit the screen

Press [RETURN] several times.

### ■ To delete a playlist during play

- 1 Press [DELETE].**

- A confirmation message is displayed.

- 2 Press [◀] to select “Delete” and then press [ENTER].**

### For your reference

- You can use fast-forward, rewind, pause and slow-motion while playing playlists just as you can during normal play.

## Editing playlists with SUB MENU button

**RAM -RW(VR)** (Properties only)

### Preparation

- Create playlists. (→ 40)
- **RAM** Release protection (disc → 55, cartridge → 55).
- Press [DRIVE SELECT] to select the DVD.

- 1 While stopped**  
Press [FUNCTIONS].
- 2 Press [▲, ▼] to select “To Others” and then press [ENTER].**
- 3 Press [▲, ▼] to select “Playlists” and then press [ENTER].**
- 4 Press [▲, ▼, ◀, ▶] to select a playlist.**  
• To show other pages → 37
- 5 Press [SUB MENU].**
- 6 Press [▲, ▼] to select a desired item and then press [ENTER].**

e.g., **RAM**

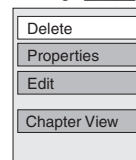

## Playlist operations

### ■ Delete

**RAM** (Multiple editing, → 37)

- Follow steps 1 to 5 of “Editing playlists with SUB MENU button”. (→ Above)

- 6 Press [▲, ▼] to select “Delete” and then press [ENTER].**
- 7 Press [◀] to select “Delete” and then press [ENTER].**

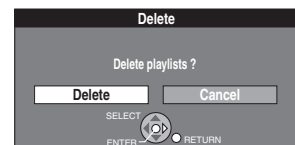

- The playlist is deleted.
- **Once deleted, the playlists cannot be restored.**  
Make certain before proceeding.
- Even if you delete a playlist, the original title is not deleted.

### ■ Properties

**RAM -RW(VR)**

- Follow steps 1 to 5 of “Editing playlists with SUB MENU button”. (→ Above)

- 6 Press [▲, ▼] to select “Properties” and then press [ENTER].**

Playlist information (e.g., date and length) is shown.

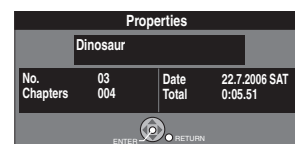

### ■ To return to the previous screen

Press [RETURN].

### ■ To exit the screen

Press [RETURN] several times.

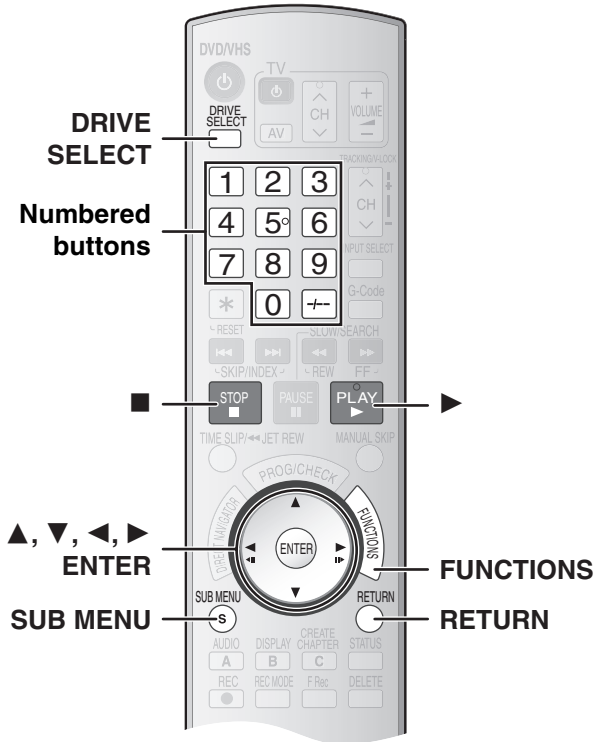

**Edit**

**RAM**

You can edit the playlist in various ways.

**Preparation**

- Create playlists. (→ 40)
- **RAM** Release protection (disc → 55, cartridge → 55).
- Press [DRIVE SELECT] to select the DVD.

- 1 While stopped**  
Press [FUNCTIONS].
- 2 Press [▲, ▼] to select “To Others” and then press [ENTER].**

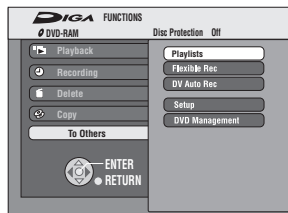

- 3 Press [▲, ▼] to select “Playlists” and then press [ENTER].**
  - Playlists are not displayed if you have not created any playlist on the inserted disc.
- 4 Press [▲, ▼, ◀, ▶] to select a playlist.**
  - To show other pages → 37
- 5 Press [SUB MENU], press [▲, ▼] to select “Edit” and then press [ENTER].**
- 6 Press [▲, ▼] to select a desired item and then press [ENTER].**

e.g., **RAM**

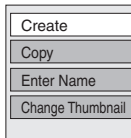

**To return to the previous screen**

Press [RETURN].

**To exit the screen**

Press [RETURN] several times.

**Create**

- Follow steps 1 to 5 of “Edit”. (→ Left)

- 6 Press [▲, ▼] to select “Create” and then press [ENTER].**

Refer to “Creating playlists”, steps 5 to 8. (→ 40)

**Copy**

(Multiple editing, → 37)

- Follow steps 1 to 5 of “Edit”. (→ Left)

- 6 Press [▲, ▼] to select “Copy” and then press [ENTER].**
- 7 Press [◀] to select “Copy” and then press [ENTER].**



**Enter Name**

- Follow steps 1 to 5 of “Edit”. (→ Left)

- 6 Press [▲, ▼] to select “Enter Name” and then press [ENTER].**

Refer to “Entering text”. (→ 52)

**Change Thumbnail**

- Follow steps 1 to 5 of “Edit”. (→ Left)

You can change the image to be shown as a thumbnail picture in the Playlist View screen.

- 6 Press [▲, ▼] to select “Change Thumbnail” and then press [ENTER].**
- 7 Press [▶, PLAY] to play.**
- 8 Press [ENTER] at the point you want to display.**
  - For quicker editing → 39
  - To change to another point in the same title:
    - Press [▲, ▼] to select “Change”, press [▶, PLAY] and then repeat step 8.

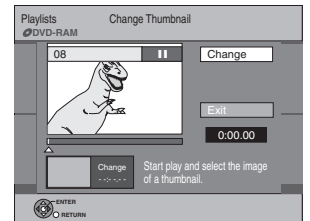

- 9 Press [▲, ▼] to select “Exit” and then press [ENTER].**

- The displayed scene is changed at this point.

## Chapter operations

### Chapter View

**RAM -RW(VR)** (Play only)

- Follow steps 1 to 4 of "Edit". (→ 42)

You can play and edit the chapters in a playlist.

**5 Press [SUB MENU], press [▲, ▼] to select "Chapter View" and then press [ENTER].**

**6 Press [▲, ▼, ◀, ▶] to select a desired chapter.**

- You can also select a chapter from the Chapter View screen by entering a 3-digit number with the numbered buttons.

e.g.: "5": [0]→[0]→[5]  
 "15": [0]→[1]→[5]

e.g., **RAM**

- If you enter a number larger than the total number of chapters, the last chapter is selected.

- Editing chapters in a playlist does not modify the source titles or the source chapters.

- To show other pages → 37
- To start play → Press [ENTER].
- To stop play → Press [■, STOP].
- To edit → Follow the steps below.

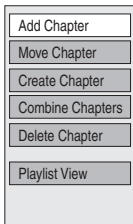

**7 Press [SUB MENU].**

**8 Press [▲, ▼] to select a desired item and then press [ENTER].**

### Add Chapter

**RAM**

- Follow steps 1 to 7 of "Chapter View". (→ Above)

**8 Press [▲, ▼] to select "Add Chapter" and then press [ENTER].**

Refer to "Creating playlists", steps 5 to 8. (→ 40)

### Move Chapter

**RAM**

- Follow steps 1 to 7 of "Chapter View". (→ Above)

**8 Press [▲, ▼] to select "Move Chapter" and then press [ENTER].**

**9 Press [▲, ▼, ◀, ▶] to select the position to insert the chapter and then press [ENTER].**

- The chapter is moved and inserted before the highlight chapter.

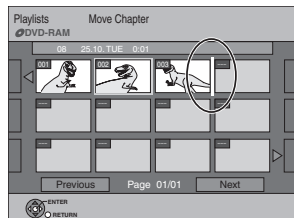

### Create Chapter

**RAM**

- Follow steps 1 to 7 of "Chapter View". (→ Left)

**8 Press [▲, ▼] to select "Create Chapter" and then press [ENTER].**

**9 Press [ENTER] at the point you want to divide.**

- For quicker editing → 39
- Repeat this step to select other division points.

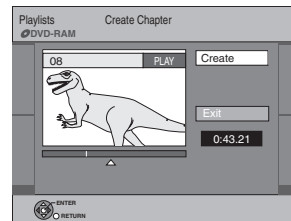

**10 Press [▲, ▼] to select "Exit" and then press [ENTER].**

### For your reference

- The divided titles retain the name of the original title. They also retain the CPRM property (→ 62) of the original.
- Video and audio just before and after the division point will be momentarily cut out.
- It is not possible to carry out "Create Chapter" in the following cases:
  - When the resulting part(s) are extremely short.
  - When the total number of titles is more than 99.

### Combine Chapters

**RAM**

- Follow steps 1 to 7 of "Chapter View". (→ Left)

**8 Press [▲, ▼] to select "Combine Chapters" and then press [ENTER].**

**9 Press [◀] to select "Combine" and then press [ENTER].**

- The selected chapter and next chapter are combined.

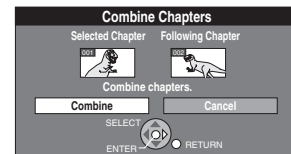

### Delete Chapter

**RAM** (Multiple editing → 37)

- Follow steps 1 to 7 of "Chapter View". (→ Left)

**8 Press [▲, ▼] to select "Delete Chapter" and then press [ENTER].**

**9 Press [◀] to select "Delete" and then press [ENTER].**

- Even if you delete the chapter, the original title is not deleted.
- The playlist itself is deleted if you delete all the chapters in it.
- **Once deleted, the playlists cannot be restored.** Make certain before proceeding.

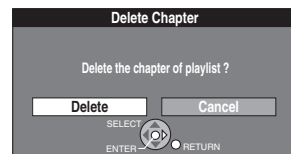

### Playlist View

**RAM -RW(VR)**

- Follow steps 1 to 7 of "Chapter View". (→ Left)

**8 Press [▲, ▼] to select "Playlist View" and then press [ENTER].**

You return to the Playlist View screen.

# Transfer (Copying)

## Before transferring (copying)

You can select from a variety of methods to transfer (copy) on this unit.  
You cannot transfer (copy) titles which have been treated to prevent copying.

Direction		Type of transfer (copying) you want	Suitable methods
From	To		
VHS	DVD-RAM, DVD-R, DVD-R DL, DVD-RW(DVD-Video format), +R, +R DL or +RW	<b>Easy transferring (copying) with one button</b> ●When you want to transfer (copy) from a selected start point to the end of the tape	One Touch Transfer (→ 45)
		<b>Transferring (copying) with detailed settings</b> ●When you want to transfer (copy) from a selected start point to the end of the tape ●When you want to transfer (copy) to fit in the remaining capacity of the disc ●When you want to transfer (copy) for a limited amount of time	GUI Transfer (→ 46)
DVD-RAM, +RW or DVD-RW (DVD Video Recording format)	VHS	<b>Easy transferring (copying) with one button</b> ●When you want to transfer (copy) a whole disc ●When you want to transfer (copy) from the beginning of a selected title or playlist to the end of the disc*	One Touch Transfer (→ 47)
		<b>Transferring (copying) with detailed settings</b> ●When you want to transfer (copy) multiple titles and playlists*	GUI Transfer (→ 48)
DVD-R, DVD-R DL, DVD-RW (DVD-Video format), +R or +R DL	VHS	<b>Easy transferring (copying) with one button</b> ●When you want to transfer (copy) a whole disc ●When you want to transfer (copy) from the beginning of the selected title to the end of the disc	One Touch Transfer (→ 47)
		<b>Transferring (copying) with detailed settings</b>	Cannot transfer
Finalized DVD-R, DVD-R DL, DVD-RW(DVD-Video format), +R, +R DL or DVD-Video on sale that are not copy-protected, etc.	VHS	<b>Easy transferring (copying) with one button</b>	Cannot transfer
		<b>Transferring (copying) with detailed settings</b> ●When you want to transfer (copy) a whole disc ●When you want to transfer only for a limited amount of time	DVD-Video Transfer (→ 49)

\* **+RW** Since you cannot create playlists on +RW, you cannot transfer (copy) them either.

### ■ Caution for transfer (copying) from VHS to DVD

- Copy-protected video cassettes cannot be transferred (copied). Most of the commercially sold/purchased video cassettes are copy-protected to prevent illegal reproduction and they cannot be transferred (copied).
- When a copy-protected cassette is inserted, a message appears on the display and the recording stops.

#### Only the following operations are allowed while transferring (copying):

- Stopping transfer (copy) (One Touch or GUI Transfer) by pressing and holding [RETURN] for about 3 seconds or more.
- Stopping transfer (copy) (One Touch Transfer) by pressing [■, STOP].

#### When transfer (copying) starts, the following operation also starts automatically

- "On-Screen Messages" in the Display menu in Setup → "Off" (→ 58) (One Touch or GUI Transfer)

**In order to play a DVD-R, DVD-R DL, DVD-RW (DVD-Video format), +R or +R DL recorded using this unit on another playback source, the disc must be finalized (→ 56).**

### ■ Caution for transfer (copying) from DVD to VHS

- Copy-protected discs cannot be transferred (copied). Most DVD-Videos are copy-protected to prevent illegal reproduction and they cannot be transferred (copied).

#### Only the following operations are allowed while transferring (copying):

- Stopping transfer (copy) (One Touch or GUI Transfer) by pressing and holding [RETURN] for about 3 seconds or more.
- Stopping transfer (copy) (One Touch Transfer) by pressing [■, STOP].

#### When transfer (copying) is started, the following operations also start automatically

- "On-Screen Messages" in the Display menu in Setup → "Off" (→ 58) (One Touch or GUI Transfer)
- **RAM** Audio output when playing back DVD → Stereo (LR)

When the playback location of the disc is memorized by the resume play function (→ 26) and you start transferring (copying), the transfer (copying) is executed from the top of the title which contains the starting position of playback to the end of the disc.



## Transfer (Copying) from VHS

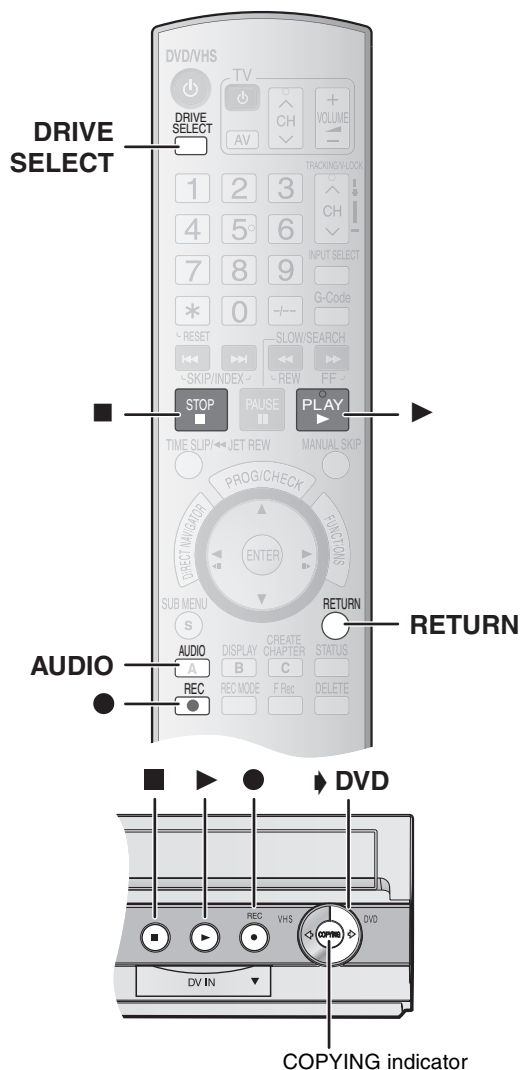

- While both DVD and VHS are stopped  
Press and hold [▶ DVD, COPYING] on the main unit for about 3 seconds or more (until “START” on the unit’s display stops flashing).

• Check if transferring (copying) starts properly.

e.g.: **RAM**

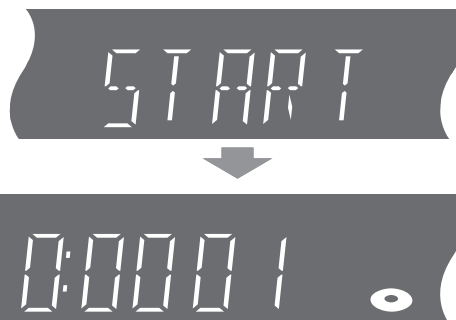

• Transferring (copying) is automatically stopped when the tape reaches its end or the disc becomes full.

**[R] [-R DL] [-RW(V)] [+R] [+R DL]**  
When the screen on the right appears before recording starts, press [●, REC] or [▶, PLAY] on the main unit to copy the disc with or without finalizing.

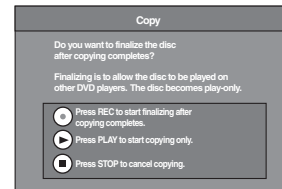

- If you press [●, REC] on the main unit, the disc will automatically be finalized after transferring (copying) completes.
- If you press [▶, PLAY] on the main unit, you can start transferring (copying) without finalizing.
- If you press [■, STOP] on the main unit, you can cancel the transfer (copy).

- Check if transfer (copying) starts properly.
- Transfer (copying) is automatically stopped when the tape reaches its end or the disc becomes full.
- If you press [●, REC] on the main unit to finalize; After finalizing, the discs become play-only and you can play them on other DVD equipment. However, you can no longer record or edit.
- **Finalizing will not start if copying is not completed (e.g., due to shortage of remaining disc space).**

### ■ One Touch Transfer (copying) (VHS → DVD)

**RAM [-R] [-R DL] [-RW(V)] [+R] [+R DL] [+RW]**

You can transfer (copy) programmes recorded on a video cassette onto a disc with one stroke of the button.

In One Touch Transfer (copying), programmes are automatically transferred (copied) onto the disc from the location of playback at the time when the transfer (copying) of the tape starts.

#### Preparation

- Select the unit viewing channel (e.g. AV input) on the TV.

#### VHS (Recording source)

- Press [DRIVE SELECT] to select the VHS.
- Insert the video cassette containing the programme to be copied. (→ 17)
- Press [▶, PLAY] to play the video cassette and then press [AUDIO] to select the audio type you wish to record.
- Stop the tape at the position where you wish to start recording.

#### DVD (Recording target)

- Press [DRIVE SELECT] to select the DVD.
- **RAM** Release protection. (disc → 55, cartridge → 55)
- Insert a disc and confirm there is sufficient empty space for recording on it. (→ 17, 36)
- Select the recording mode. (→ 18)

#### Settings (→ 59, TV System)

- When transferring (copying) an NTSC tape to a DVD
  - Set “TV System” on “Connection” in Setup to “NTSC”. Be certain that the inserted disc only contains NTSC video contents.
- When transferring (copying) a PAL tape to a DVD
  - Set “TV System” on “Connection” in Setup to “PAL”. Be certain that the inserted disc only contains PAL video contents.

### ■ To stop transfer (copying) in the middle

Press [■, STOP] or press and hold [RETURN] for about 3 seconds or more.

- However you cannot stop finalize after it has started.

#### Notes

- While One Touch Transfer (Copying) is activated, a timer recording cannot be started.
- When the transfer (copying) is not started or not executed, the “COPYING” indicator blinks for about 7 seconds. Check if the unit is properly prepared.

### ■ Dividing a title to be transferred (copied)

When transferring (copying) from VHS to DVD, the title is divided by index signal (→ 33) detected and then recorded. You can search desired titles with the Direct Navigator (→ 26) after transfer (copy) to DVD.

- Titles recorded within 15 minutes of each other may not be divided properly.
- The recording time may become longer than the original title depending on the number of index signals.

**If you want to transfer (copy) without dividing the contents into titles, follow the method below.**

- Set “Time Setting” to “On” on the GUI Transfer (→ 46).

## ■ GUI (Graphical User Interface) Transfer (Copying) (VHS → DVD)

RAM -R -R DL -RW(V) +R +R DL +RW

You can transfer (copy) programmes recorded on a video cassette onto a disc from the location\* of playback as of the transfer (copying) start of the tape.

\* When you set the recording mode to “FR” (→ right) and “Time Setting” to “Off” (→ right), you can transfer (copy) the whole tape from the beginning to the end.

### Preparation

● Select the unit viewing channel (e.g. AV input) on the TV.

### VHS (Recording source)

- Press [DRIVE SELECT] to select the VHS.
- Insert the video cassette containing the programme to be copied. (→ 17)
- Press [▶], PLAY to play the video cassette and then press [AUDIO] to select the audio type you wish to record.
- Stop the tape at the position where you wish to start recording.

### DVD (Recording target)

- Press [DRIVE SELECT] to select the DVD.
- **RAM** Release protection. (disc → 55, cartridge → 55)
- Insert a disc and confirm there is sufficient empty space for recording on it. (→ 17, 36)
- Select the recording mode. (→ 18)

### Settings (→ 59, TV System)

- When transferring (copying) an NTSC tape to a DVD
  - Set “TV System” on “Connection” in Setup to “NTSC”. Be certain that the inserted disc only contains NTSC video contents.
- When transferring (copying) a PAL tape to a DVD
  - Set “TV System” on “Connection” in Setup to “PAL”. Be certain that the inserted disc only contains PAL video contents.

## 1 Press [DRIVE SELECT] to select the VHS.

## 2 While both DVD and VHS are stopped Press [FUNCTIONS].

## 3 Press [▲, ▼] to select “Copy” and then press [ENTER].

## 4 Set the transfer (copying) direction.

- Set “Source” to “VHS”.
- If you are not going to change the transfer (copy) direction, press [▼] and skip to step 5.

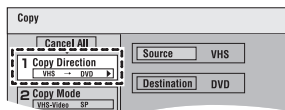

### ■ To change the setting

- (1) Make sure “Copy Direction” is selected and press [▶].
- (2) Make sure “Source” is selected and press [ENTER].
- (3) Press [▲, ▼] to select “VHS” and then press [ENTER].
  - When you set “Source” to “VHS”, “DVD” is automatically selected in “Destination”.
- (4) Press [◀].
- (5) Press [▼].

## 5 Set the recording mode.

- If you are not going to change the recording mode, press [▼] and skip to step 6.

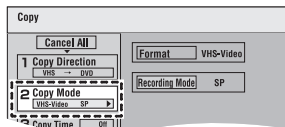

### ■ To change the setting

- (1) Make sure “Copy Mode” is selected and press [▶].
- (2) Make sure “Recording Mode” is selected and press [ENTER].
- (3) Press [▲, ▼] to select the recording mode (XP, SP, LP, EP or FR) and then press [ENTER].
  - About FR mode (→ right)
- (4) Press [◀].
- (5) Press [▼].

## 6 Set the time limit.

- If you are not going to change the recording time, press [▼] and skip to step 7.

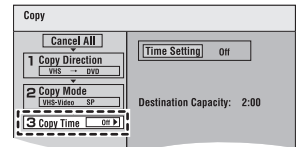

### ■ To change the setting

- (1) Make sure “Copy Time” is selected and press [▶].
- (2) Make sure “Time Setting” is selected and press [ENTER].
- (3) Press [▲, ▼] to select the time setting (“On” or “Off”) and then press [ENTER].
  - When you select “Off”, proceed to Step (6) below.
- (4) Press [▼] to select “Copy Time” and then press [ENTER].
- (5) Press [◀, ▶] to select “Hour” and “Min.” and press [▲, ▼] to set the recording time and then press [ENTER].
  - You can also set the time with the numbered buttons.
  - Maximum recording time is 8 hours.
- (6) Press [◀].
- (7) Press [▼].

## 7 Make sure “Start Copying” is selected and press [ENTER].

- The confirmation screen appears.

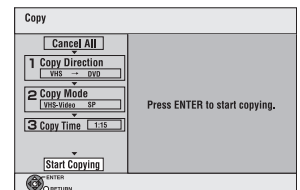

## 8 Press [◀] to select “Yes” and then press [ENTER].

## -R -R DL -RW(V) +R +R DL Press [◀, ▶] to select “Copy & Finalize” or “Copy Only” and then press [ENTER].

- Transfer (copying) starts.
- Transfer (copying) is automatically stopped when the tape reaches the end, the remaining capacity of the disc is filled or when a timer recording starts. (A message appears on the TV screen and then disappears a few seconds later.)
- If “Copy & Finalize” is selected; After finalizing, the disc becomes play-only and you can play them on other DVD equipment. However, you can no longer record or edit.
- Finalizing will not start if copying is not completed (e.g., due to shortage of remaining disc space).

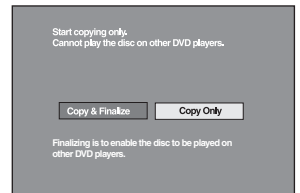

### ■ To stop transfer (copying) in the middle (process)

- Press and hold [RETURN] for about 3 seconds or more.
- However you cannot stop finalize after it has started.

### ■ About FR mode

#### When “Time Setting” is set to “Off” in step 6 above:

- The recording mode is automatically selected by estimating the remaining capacity of the disc for transfer (copying) of only the recorded parts in the video cassette (unrecorded parts will not be recorded).
- When you press [ENTER] to start transfer (copy), the tape is automatically fast-forwarded to the end and then fast-rewound to the beginning before the transfer (copying) is actually started. It may take time to start transfer (copy). If the remaining capacity of the disc is insufficient, the transfer (copying) will be stopped in the middle.
- The recording is divided into titles every time the tape index signals are detected.

#### When “Time Setting” is set to “On” in step 6 above:

- The recording mode is automatically determined by estimating the remaining capacity of the disc for transfer (copying) of the contents equivalent to the recording time set from the start point of the transfer (copying) on the video cassette (unrecorded parts will also be recorded).
- The recording is not divided into titles.

## Transfer (Copying) from DVD

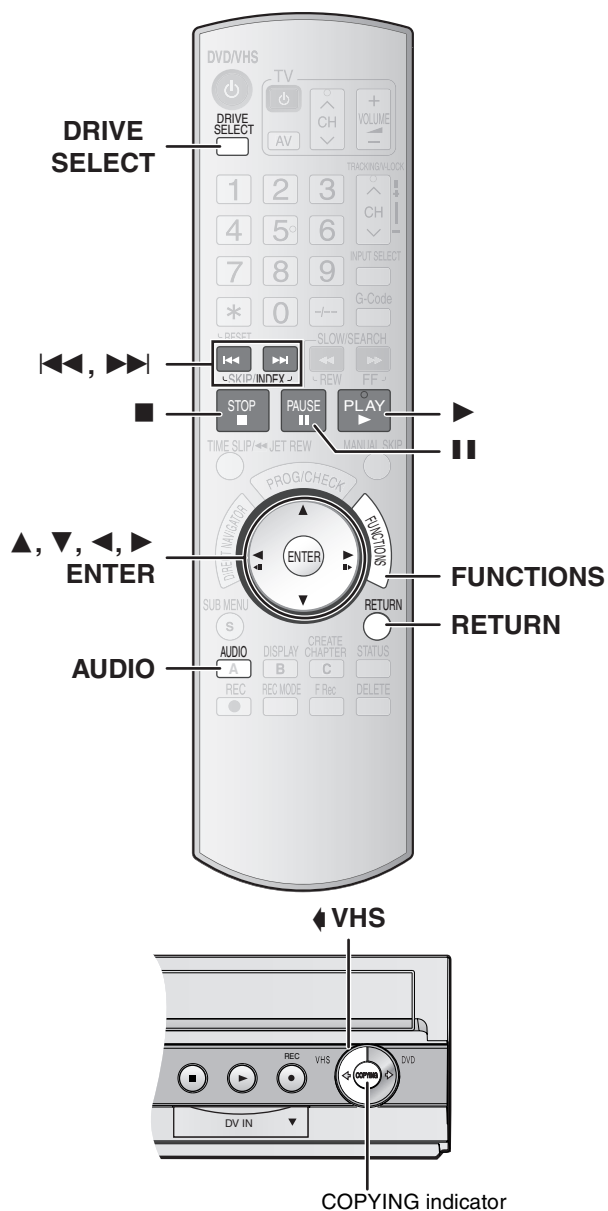

### ■ One Touch Transfer (copying) (DVD → VHS)

**RAM -R -R DL -RW(V) +R +R DL +RW -RW(VR)**

You can transfer (copy) titles recorded on a disc onto a video cassette with one stroke of the button.

In One Touch Transfer (copying), all contents on the disc are automatically transferred (copied) onto the video cassette.

#### Preparation

- Select the unit viewing channel (e.g. AV input) on the TV.

#### DVD (Recording source)

- Press [DRIVE SELECT] to select the DVD.
- Insert the disc containing the title to be copied. (→ 17)
- Playback the DVD. (→ Left)
- **RAM -RW(VR)** Press [AUDIO] to select the audio you wish to record.
- Stop the DVD. (→ Left)

#### VHS (Recording target)

- Press [DRIVE SELECT] to select the VHS.
- Insert a video cassette with an intact accidental erasure prevention tab. (→ 17)
- Confirm that the remaining tape time is sufficient for recording. (→ 33)
- Select the recording mode. (→ 18)

#### Settings (→ 59, TV System)

- When transferring (copying) an NTSC disc to a tape
  - Set "TV System" on "Connection" in Setup to "NTSC".
- When transferring (copying) a PAL disc to a tape
  - Set "TV System" on "Connection" in Setup to "PAL".

### 1 Press and hold [VHS, COPYING] on the main unit for about 3 seconds or more (until "START" on the unit's display stops flashing).

- Check if transfer (copying) starts properly.
- Transferring (copying) is automatically completed when playback of the disc is finished or the tape reaches its end.



Remaining time



#### ■ When you transfer (copy) a whole disc Make sure that the DVD is stopped.

- When the resume play function is activated (→ 26), press [■, STOP] to deactivate it.

#### ■ When you transfer (copy) a title from the beginning of the selected title to the end of the disc

#### ■ When you transfer (copy) a playlist from the beginning of the selected playlist to the last playlist

Press [▶, PLAY] to play back the desired title (→ 26) or playlist (→ 41).

- You can transfer (copy) (a title or playlist) while playback is paused by pressing [■, PAUSE].
- You cannot transfer (copy) a playlist which is longer than 8 hours. (When you transfer (copy) multiple playlists, the playlist which is longer than 8 hours is omitted.)

#### ■ To stop transfer (copying) in the middle

Press [■, STOP] or press and hold [RETURN] for about 3 seconds or more.

#### Notes

- While One Touch Transfer (Copying) is activated, a timer recording cannot be started.
- If you start transfer (copying) when the resume play function (→ 26) is activated, the DVD is transferred (copied) from the beginning of the title which you stopped.

#### ■ About Recording VISS (→ 33)

When transferring (copying) from DVD to VHS, the index signal is automatically recorded for each title. You can search desired titles with [◀◀, INDEX] or [▶▶, INDEX].

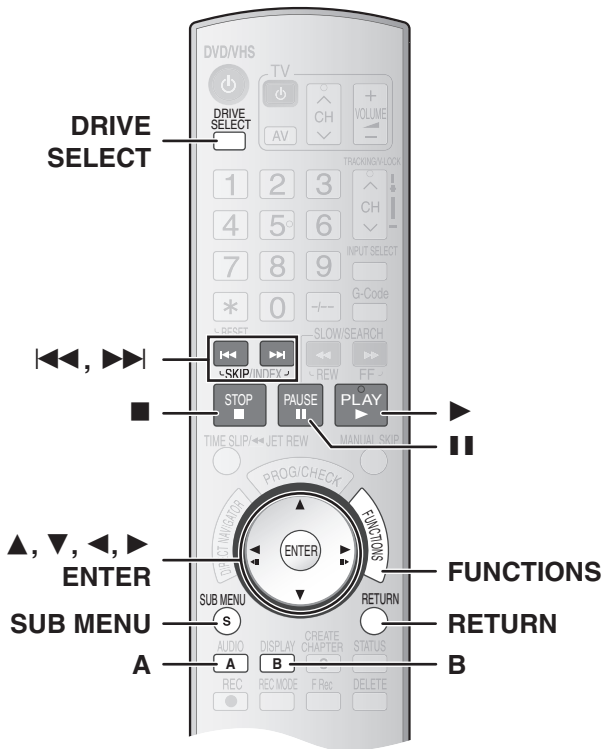

**GUI (Graphical User Interface)  
Transfer (copying) (DVD → VHS)**

**RAM -RW(VR)**

You can transfer (copy) multiple titles and playlists that are recorded on a disc onto a video cassette.

**Preparation**

- Select the unit viewing channel (e.g. AV input) on the TV.

**DVD (Recording source)**

- Insert the disc containing the programme to be copied. (→ 17)
- **RAM -RW(VR)** Select the audio to be played (the audio to be recorded) beforehand.

**VHS (Recording target)**

- Insert a video cassette with a secure accidental erasure prevention tab. (→ 17)
- Confirm that the remaining tape time is sufficient for recording. (→ 33)

**Settings (→ 59, TV System)**

- When transferring (copying) an NTSC disc to a tape
  - Set "TV System" on "Connection" in Setup to "NTSC".
- When transferring (copying) a PAL disc to a tape
  - Set "TV System" on "Connection" in Setup to "PAL".

**1 Press [DRIVE SELECT] to select the DVD.**

**2 While both DVD and VHS are stopped Press [FUNCTIONS].**

**3 Select "Copy" with [▲, ▼] and press [ENTER].**

**4 Set "Copy Direction".**

- Set "Source" to "DVD".
- If you are not going to change the transfer (copy) direction, press [▼], then skip to step 5.

**■ To change the setting**

- (1) Make sure "Copy Direction" is selected and press [▶].
- (2) Make sure "Source" is selected and press [ENTER].
- (3) Press [▲, ▼] to select "DVD" and press [ENTER].
  - When you set "Source" to "DVD", "VHS" is automatically selected in "Destination".
- (4) Press [◀].
- (5) Press [▼].

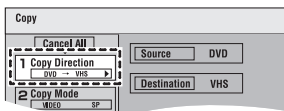

**5 Set the recording mode.**

- If you are not going to change the recording mode, press [▼], then skip to step 6.

**■ To Change the setting**

- (1) Make sure "Copy Mode" is selected and press [▶].
- (2) Make sure "Recording Mode" is selected and press [ENTER].
- (3) Select recording mode (SP, LP\* or EP) with [▲, ▼] and press [ENTER].
  - \* Only when transferring (copying) in PAL
- (4) Press [◀].
- (5) Press [▼].

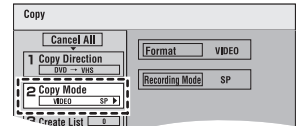

**6 Register titles and playlists for transfer (copying).**

- If you are going to transfer (copy) a registered list without making any changes to it, press [▼], then skip to step 7.

**■ To set for the registration**

- (1) Make sure "Create List" is selected and press [▶].
- (2) Make sure "New item (Total = 0)" is selected and press [ENTER].
- (3) Press [A] to select "VIDEO" or press [B] to select "Playlists".
  - You can also select the view by selecting "Other View" from the SUB MENU.
    - ① Press [SUB MENU].
    - ② Make sure "Other View" is selected and press [ENTER] twice.
- (4) Press [▲, ▼, ◀, ▶] to select the title or playlist and press [ENTER].
  - You can register multiple titles or playlists to the transferring (copying) list by repeating the above steps (2) to (4).
  - To show other pages → below
  - Multiple editing → below
  - Transferring (copying) list display and convenient functions → 49
- (5) Press [◀].
  - Before pressing [◀], make sure that the value on "Size" is smaller than the value in "Destination Remaining".
- (6) Press [▼].

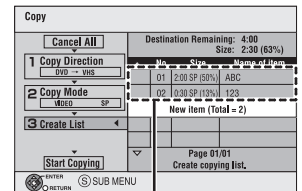
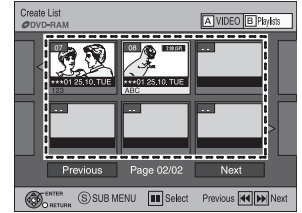
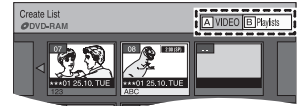
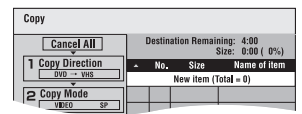
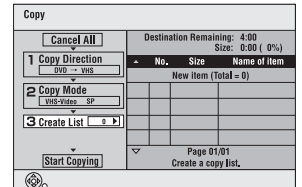

Registered titles

**7 When you finish creating the transferring (copying) list, Make sure to select "Start Copying" and press [ENTER].**

- The confirmation screen appears.

**8 Select "Yes" with [◀] and press [ENTER].**

- Transfer (copying) is started.

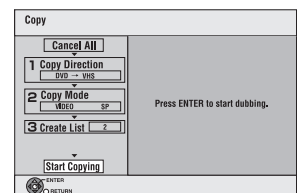

**■ To stop transfer (copying) in the middle**

Press and hold [RETURN] for about 3 seconds or more.

**Various operations**

**■ To show other pages**

- Press [◀◀, SKIP] or [▶▶, SKIP].
- Press [▲, ▼, ◀, ▶] to select "Previous" or "Next" and press [ENTER] to show other pages.

**■ Multiple editing**

- Select with [▲, ▼, ◀, ▶] and press [||, PAUSE]. (Repeat this to select multiple items.)
- Press [ENTER] to register to the list.
- A check mark appears. Press [||, PAUSE] again to cancel.
- When you switch between the "VIDEO" and "Playlists" tab, the check mark is cancelled.
- Titles or playlists are registered to the transferring (copying) list in the ascending order of the title number.



## Transferring (copying) list display and convenient functions

### ■ Transferring (copying) list icons

🔒: Title with "One time only recording" restriction (→ 62, CPRM)

Ⓜ: Title or playlist contains still picture(s)

- Titles and playlists that contain only still pictures cannot be transferred (copied).
- Titles and playlists displaying the following marks cannot be selected.

×: Unable to play

NTSC/PAL: NTSC/PAL

- Titles or playlists recorded using a different encoding system from that of the TV system currently selected on the unit.

### ■ To edit the transferring (copying) list

In step 6 (→ 48)

1 Select a desired item in the transferring (copying) list with [▲, ▼] and press [SUB MENU].

2 Press [▲, ▼] to select the operation and press [ENTER].

e.g., **RAM**

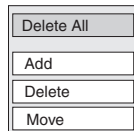

#### Delete All:

Delete all items registered on the transferring (copying) list.

- Press [◀] to select "Yes" and press [ENTER].

#### Add:

Add new items to the transferring (copying) list.

- Press [▲, ▼, ◀, ▶] to select the titles and playlists to be added and press [ENTER].

#### Delete:

Delete the selected item.

- Press [◀] to select "Yes" and press [ENTER].
- Multiple editing → 48

#### Move:

Move selected items or change the order of items on the transferring (copying) list.

- Press [▲, ▼] to select the destination and press [ENTER].

### To cancel all registered transferring (copying) settings and lists

After performing steps 1 to 6 of "GUI (Graphical User Interface)

Transfer (copying) (DVD → VHS)" (→ 48),

1 Press [▲] to select "Cancel All" and press [ENTER].

2 Press [◀] to select "Yes" and press [ENTER].

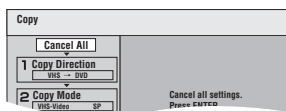

- The settings and lists may be cancelled in the following situations.

- When a title or a playlist has been recorded or deleted at the transferring (copying) source.
- When steps have been taken, for instance, to turn off the unit or open the tray.

## Transfer (copying) a finalized DVD-R, DVD-R DL, DVD-RW (DVD-Video format), +R, +R DL or DVD-Video

You can transfer (copy) the contents of a disc being played onto a video cassette for the set time while playing the disc.

### ● Operations and on screen displays during transfer (copying) are also recorded.

- Almost all DVD-Video on sale have been treated to prevent illegal copying and cannot be transferred (copied).
- The following cannot be transferred (copied): DVD-Audio, Video CD, Audio CD and so on.

After performing steps 1 to 5 of "GUI (Graphical User Interface) Transfer (copying) (DVD → VHS)" (→ 48),

### 6 Set "Copy Time".

- If you are not going to change the setting, press [▼], then skip to step 7.

### ■ Setting the unit to transfer (copy) according to the set time

- (1) Make sure "Copy Time" is selected and press [▶].
- (2) Make sure "Time Setting" is selected and press [ENTER].
  - Setting the unit to transfer (copy) all the content on the disc
  - (3) Press [▲, ▼] to select "Off" and press [ENTER].
  - (4) Press [◀].
  - (5) Press [▼].
  - Setting the transfer (copying) time
  - (3) Press [▲, ▼] to select "On" and press [ENTER].
  - (4) Press [▼] to select "Copy Time" and press [ENTER].
  - (5) Press [◀, ▶] to select "Hour" and "Min." and press [▲, ▼] to set the recording time and then press [ENTER].
    - You can also set the time with the numbered buttons.
    - Maximum recording time is 8 hours.
  - (6) Press [◀].
  - (7) Press [▼].

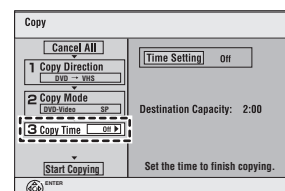

### 7 Make sure "Start Copying" is selected and press [ENTER].

Press [◀] to select "Yes" and press [ENTER] to start transfer (copy).

The disc top menu is displayed.

- Disc play automatically begins from title 1 when "Title 1" is selected from the "Auto-Play Select" menu when finalizing the disc (→ 55).

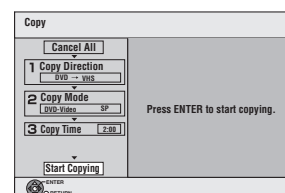

### 8 When the top menu is displayed Press [▲, ▼, ◀, ▶] to select the title you want to start transferring (copying) and press [ENTER].

- While playing in order, all the titles after the selected title are recorded until the set time.
- After the last title on the disc has finished playing the top menu is recorded until the set time is reached.

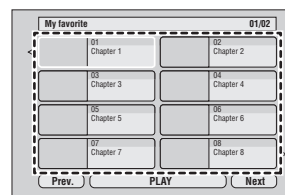

### ■ To stop transfer (copying) in the middle

Press [■, STOP] or press and hold [RETURN] for about 3 seconds or more.

#### Notes

- The screen saver on the right is recorded at the beginning.
- If play does not begin automatically or if the top menu is not displayed automatically, press [▶, PLAY] to start.
- The contents is recorded as 1 title from the beginning of transfer (copy) to the end (even if there are multiple programmes).
- "REC" only appears on the unit's display when transferring from DVD-Video.



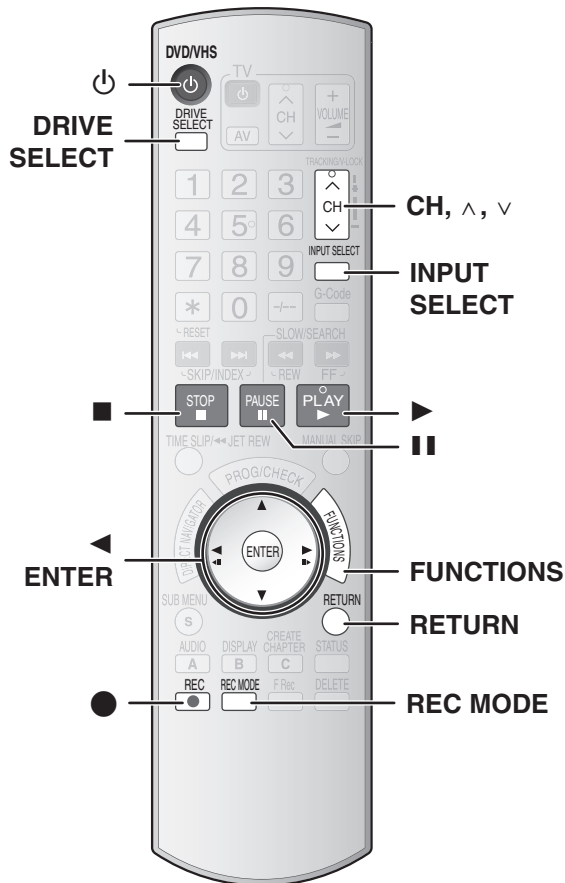

**Recording from an external device**

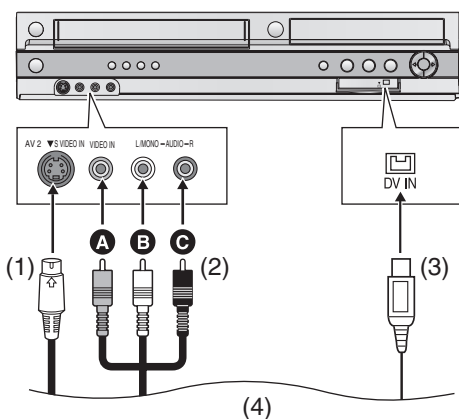

- (1) S Video cable (not supplied)
- (2) Audio/Video cable (not supplied)
  - A Yellow (VIDEO)
  - B White (L)
  - C Red (R)
- (3) DV cable (IEEE 1394 4-pin, not supplied)
- (4) Playback equipment

When connecting to the AV2 input terminals or the DV IN terminal on the front of the unit.

• You can also connect to the AV1 input terminals on the rear of the unit.

Before connecting any cables, first make sure that the power for the unit and the external device are off. Then, after connecting the cables, turn on both.

**Notes**

- If the audio output from the external device is monaural, connect the audio cable to L/MONO. (Both left and right channels are recorded when connected through L/MONO.)
- The S VIDEO IN terminal achieves a more vivid picture than the VIDEO IN terminal.

**Preparation**

- Select the unit viewing channel (e.g. AV input) on the TV.

**DVD**

- RAM** **-R** **-R DL** **-RW(V)** **+R** **+R DL** **+RW**
- **RAM** Release protection (disc → 55, cartridge → 55).
- Press [DRIVE SELECT] to select the DVD.
- When recording bilingual programmes

**RAM**

When both M 1 and M 2 are selected on the external device, you can select the audio type in playback.

- R** **-R DL** **-RW(V)** **+R** **+R DL** **+RW**

Select either M 1 or M 2 on the external device. (You cannot switch between audio types during playback.)

- When the output signal from the external device is NTSC, change the "TV System" to "NTSC" in the Setup menu (→ 59).
- This unit cannot record to discs containing both PAL and NTSC signals.

**VHS**

- Insert a video cassette with a secure accidental erasure prevention tab. (→ 17)
- Press [DRIVE SELECT] to select the VHS.

- 1 Press [REC MODE] to select the recording mode.** (→ 18)
- 2 While stopped**  
**Press [CH, ^, v] or [INPUT SELECT] to select the input channel for the external device you have connected.**
  - Select AV1, AV2 or DV.

**DVD**

Follow the above steps 1 to 2.

- 3 Start play on the external device.**
  - RAM** **-R** **-R DL** **-RW(V)** **+R** **+R DL** **+RW**
  - It is also possible to record in Flexible Recording mode (FR). Follow the steps in "Flexible Recording mode (FR)" (→ 22) after this step. (There is no need to continue to step 4.)
- 4 Press [●, REC] at the point where you want to start recording.**

**VHS**

Follow the above steps 1 to 2.

- 3 Press [▶, PLAY].**
  - Start playing the video cassette and find the recording start point.
- 4 Press [⏸, PAUSE] and then press [●, REC].**
  - Put the unit in recording standby mode.
- 5 Start play on the external device.**
- 6 Press [⏸, PAUSE] at the point where you want to start recording.**

**To skip unwanted parts**

Press [⏸, PAUSE] to pause recording. (Press [⏸, PAUSE] again to restart recording.)

**To stop recording**

Press [■, STOP].

**For your reference**

- Almost all videos and DVD software on sale have been treated to prevent illegal copying. Such software cannot be recorded.



## DV automatic recording

**RAM** **-R** **-RW(V)** **+R** **+RW**

When the "DV Auto Rec" function is used, programmes are recorded as one title.

**RAM** Chapters are created at each break in the images and if programmes were recorded continuously on the source, a playlist is created automatically.

### Preparation

- Turn off the unit and the DV equipment and connect the DV equipment to the unit's DV IN terminal.
- When the output signal from the DV equipment is NTSC, change the "TV System" to "NTSC" in the Setup menu (→ 59).
- Press [REC MODE] to select the recording mode.

### 1 Press [⏻, DVD/VHS] to turn the unit on and after the unit has started up completely, turn the DV equipment on.

The "DV Auto Rec" screen appears.

- If the "DV Auto Rec" screen does not appear, press [FUNCTIONS] and select "DV Auto Rec" in "To Others" and go to step 3.



### 2 Press [◀] to select "Rec to DVD" and then press [ENTER].

### 3 Pause play on the DV equipment at the point you want to start recording.

### 4 Check that "Rec" is selected and then press [ENTER].

- It is not possible to start recording when "Rec" is not selected.

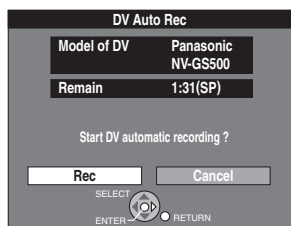

### When recording finishes

The confirmation screen appears. Press [ENTER] to finish the DV Auto Rec.

### To stop recording

Press [■, STOP].

The confirmation screen appears. Press [ENTER].

### ■ To return to the previous screen

Press [RETURN].

### ■ To exit the screen

Press [RETURN] several times.

### Notes

- Only one piece of DV equipment (e.g., digital video camera) can be connected to the unit via the DV IN terminal.
- Video cameras from other manufacturer's are not guaranteed to work.
- If the DV equipment is in a mode for operating the SD card, it is not possible to record with "DV Auto Rec".
- It is not possible to operate the unit from the connected DV equipment.
- The DV IN terminal on this unit is for use with DV equipment only. (It cannot be connected to a computer, etc.)
- The DV equipment name may not be shown correctly.
- Depending on the DV equipment, the images or the audio may not be input properly.
- The date and time information on the tape in the DV equipment will not be recorded.
- You cannot record and play simultaneously.

If the DV Auto Rec function does not work properly, check the connections and DV equipment settings then turn the unit off and back on.

**If that does not work, follow the steps for Recording from an external device.**

# Entering text

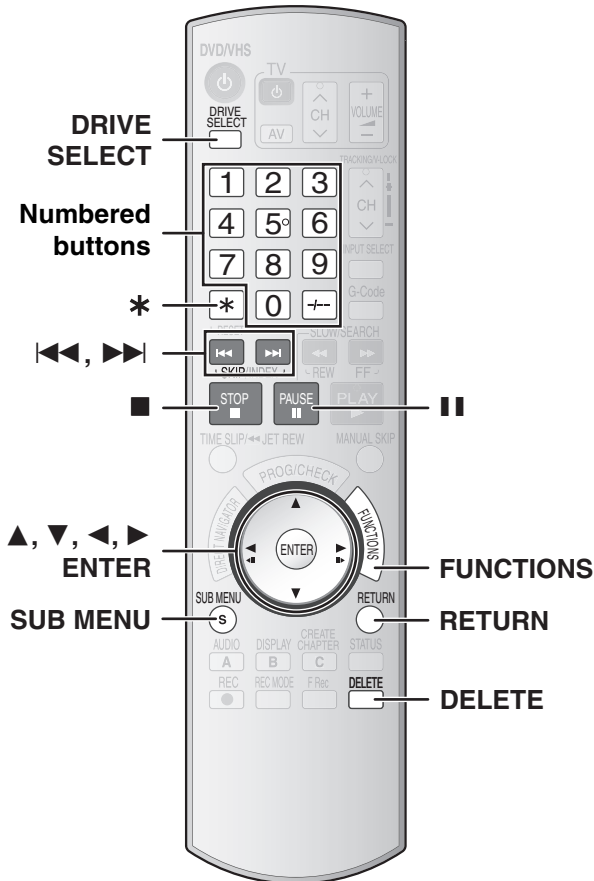

## Entering text

**RAM -R -R DL -RW(V) +R +R DL +RW**

You can give names to recorded titles, etc.  
The maximum number of characters:

RAM	Characters
• Title	64
• Title (timer recording)	44
• Playlist	64
• Disc	64

-R -R DL -RW(V) +R +R DL +RW	Characters
• Title	44
• Disc	40

### Note

- If the name is long, parts of it may not be shown in some screens.

### Preparation

- Insert a recorded disc.
- **RAM** Release protection (disc → 55, title → 38, cartridge → 55).
- Press [DRIVE SELECT] to select the DVD drive.

### 1 Show Enter Name screen.

Refer to the following pages regarding display of the Enter Name Screen.

- Title (→ 38)
- Title (timer recording) (→ 23, 24)
- Playlist (→ 42)
- Disc (→ 54)

**Name field:** shows the text you have entered

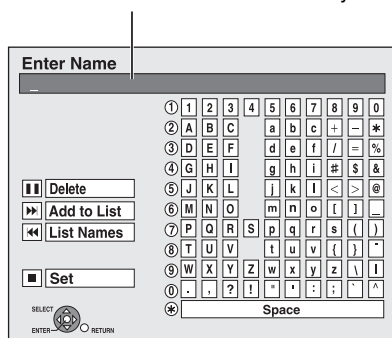

### 2 Press [▲, ▼, ◀, ▶] to select the character you want to enter and then press [ENTER].

Repeat this step to enter other characters.

#### • To delete a character

Press [▲, ▼] to select the name field and press [◀, ▶] to select the character you want to delete and then press [■, PAUSE].

#### • Using the numbered buttons to enter characters

e.g., entering the letter "R".

- (1) Press [7] to move to the 7th row.
- (2) Press [7] twice to highlight "R".
- (3) Press [ENTER].

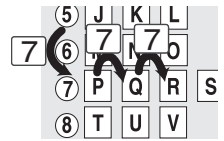

#### • To enter space

Press [\*] and press [ENTER].

#### • Add/recall names (→ below)

### 3 After you have finished entering the text

Press [■, STOP].

The name is entered and the screen disappears.

### ■ To cancel in the middle

Press [RETURN].

- Characters will not be saved.

### ■ To add a name

You can save frequently used names and recall them later.

Maximum number of saved names: 20

Maximum number of characters per name: 20

• After entering the name (step 1 to 2, Entering text)

#### 1 Press [▲, ▼, ◀, ▶] to select "Add to List" and then press [ENTER].

- You can also press [▶▶], SKIP to select "Add to List".

#### 2 Press [◀] to select "Add" and then press [ENTER].

- Press [RETURN] to cancel.

### ■ To recall an added name

#### 1 Press [▲, ▼, ◀, ▶] to select "List Names" and then press [ENTER].

- You can also press [◀◀], SKIP to select "List Names".

#### 2 Press [▲, ▼, ◀, ▶] to select the name to be recalled and then press [ENTER].

- You can also press the numbered buttons to select the name.

### ■ To delete an added name

#### 1 Press [▲, ▼, ◀, ▶] to select "List Names" and then press [ENTER].

- You can also press [◀◀], SKIP to select "List Names".

#### 2 Press [▲, ▼, ◀, ▶] to select the name to be deleted.

- You can also press the numbered buttons to select the name.

#### 3 Press [SUB MENU] to show "Delete Name" and then press [ENTER].

#### 4 Press [◀] to select "Delete" and then press [ENTER].

#### 5 Press [RETURN].

### For your reference

**-R -R DL -RW(V) +R +R DL +RW**

If you enter a long name, only part of it is shown in the Top Menu after finalization (→ 56). When entering a title name, the name that will appear in the Top Menu can be previewed in the "Title Menu Preview" window.



## Delete Navigator

### Preparation

- Insert a recorded disc.
- **RAM** Release protection (disc → 55, title → 38, cartridge → 55).
- Press [DRIVE SELECT] to select the DVD drive.

**RAM -R -R DL -RW(V) +R +R DL +RW**

- **A title cannot be restored once it is deleted.** Make certain before proceeding.
- You cannot delete while recording.
- **-R -R DL +R +R DL** Available space does not increase after deletion.
- **-RW(V) +RW** Available space increases when the title recorded last is deleted. (The recording space may increase slightly when other titles are deleted.)

- 1 While stopped**  
Press [FUNCTIONS].
- 2 Press [▲, ▼] to select “Delete” and then press [ENTER].**

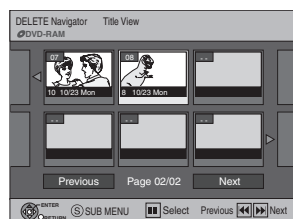

- 3 Press [▲, ▼, ◀, ▶] to select the title and then press [ENTER].**

### ■ To show other pages

Press [▲, ▼, ◀, ▶] to select “Previous” or “Next” and then press [ENTER].

- You can also press [◀◀, SKIP] or [▶▶, SKIP] to show other pages.

### ■ Multiple editing

Press [▲, ▼, ◀, ▶] to select and then press [||, PAUSE]. (Repeat)  
A check mark appears. Press [||, PAUSE] again to cancel.

- 4 Press [◀] to select “Delete” and then press [ENTER].**

## Deleting a title during play

### Preparation

- Insert a recorded disc.
- **RAM** Release protection (disc → 55, title → 38, cartridge → 55).
- Press [DRIVE SELECT] to select the DVD drive.

**RAM -R -R DL -RW(V) +R +R DL +RW**

- **A title cannot be restored once it is deleted.**  
Make certain before proceeding.

- 1 During play**  
Press [DELETE].
- 2 Press [◀] to select “Delete” and then press [ENTER].**

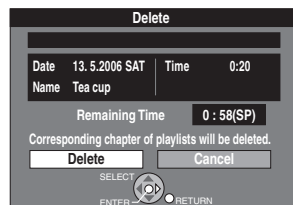

### ■ To return to the previous screen

Press [RETURN].

### ■ To exit the screen

Press [RETURN] several times.

### For your reference

- **RAM** You cannot delete while recording.
- The disc's available recording time may not increase after deleting short titles.
- **-R -R DL +R +R DL** Available space does not increase after deleting.
- **-RW(V) +RW** Available space increases when the title recorded last is deleted. (The recording space may increase slightly when other titles are deleted.)

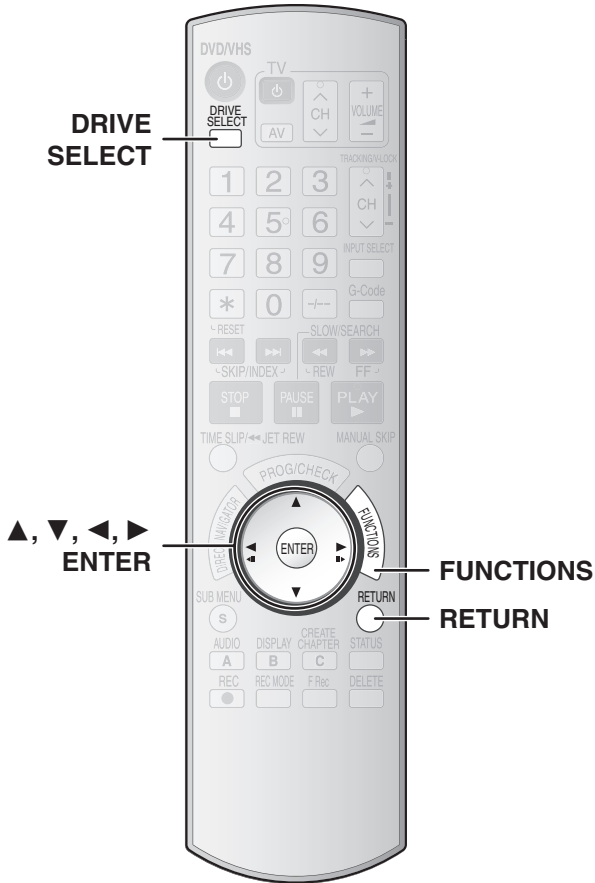

**RAM -R -R DL -RW(V) +R +R DL +RW**

### Preparation

- Insert a disc (→ 17).
- **RAM** Release protection (disc → 55, cartridge → 55).
- Press [DRIVE SELECT] to select the DVD drive.

- 1** While stopped  
Press [FUNCTIONS].
- 2** Press [**▲**, **▼**] to select “To Others” and then press [ENTER].

e.g., **RAM**



- 3** Press [**▲**, **▼**] to select “DVD Management” and then press [ENTER].

e.g., **RAM**



e.g., **-R**



- 4** Press [**▲**, **▼**] to select a desired item and press [ENTER].

You can change various settings.

- After this operation, follow the desired operation.

### ■ To return to the previous screen

Press [RETURN].

### ■ To exit the screen

Press [RETURN] several times.

## Disc Name

**RAM -R -R DL -RW(V) +R +R DL +RW**

- Follow steps 1 to 3 of “DVD Management”. (→ Above)

- 4** Press [**▲**, **▼**] to select “Disc Name” and then press [ENTER].

Refer to “Entering text” (→ 52).

- The disc name is displayed in the DVD Management window.
- With a finalized disc and a +RW, the name is displayed on the top menu.

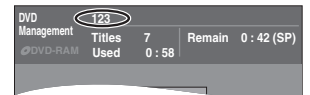

## Disc Protection

### RAM

- Follow steps 1 to 3 of “DVD Management”. (→ 54)

This allows you to protect the whole disc from accidental erasure.

- 4 Press [▲, ▼] to select “Disc Protection” and then press [ENTER].

- 5 Press [◀] to select “Yes” and then press [ENTER].

- To protect

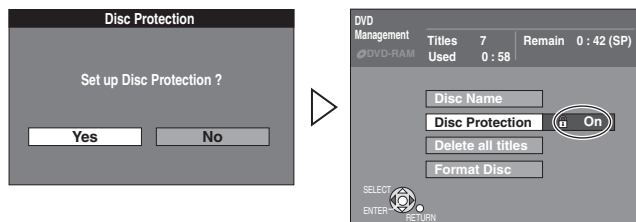

- To release protection

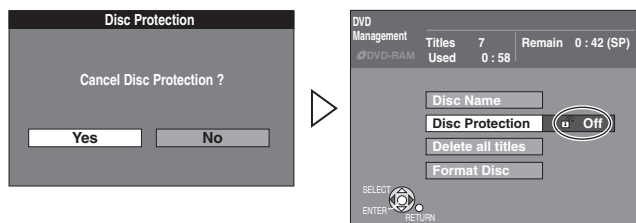

### ■ Protection of cartridge disc RAM

You can protect the contents of your discs.

- With the write-protect tab in the protect position, you cannot record to, edit, or delete from the disc.

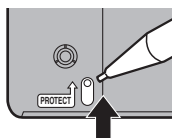

## Delete all titles

### RAM

- Follow steps 1 to 3 of “DVD Management”. (→ 54)

Once deleted, the recorded contents cannot be restored.

Make certain before proceeding.

- 4 Press [▲, ▼] to select “Delete all titles” and then press [ENTER].

- 5 Press [◀] to select “Yes” and then press [ENTER].

- 6 Press [◀] select “Start” and then press [ENTER].

- A message appears when finished.

- 7 Press [ENTER].

### Notes

- Deleting all video titles will result in all playlists also being deleted.
- “Delete all titles” does not work if one or more titles are protected.

## Auto-Play Select

### -R -R DL -RW(V) +R +R DL +RW

- Follow steps 1 to 3 of “DVD Management”. (→ 54)

Select whether to show the top menu after finalizing the disc.

(Do this before finalizing the disc.)

- 4 Press [▲, ▼] to select “Auto-Play Select” and then press [ENTER].

- 5 Press [▲, ▼] to select the desired item and then press [ENTER].



- Top Menu: The top menu appears first.
- Title 1: The disc content is played without displaying the top menu.

## Create Top Menu

### +RW

- Follow steps 1 to 3 of “DVD Management”. (→ 54)

+RW discs do not contain Top Menu data. The Top Menu is a convenient function. We recommend that you create the menu before playing a +RW disc on other equipment.

- 4 Press [▲, ▼] to select “Create Top Menu” and then press [ENTER].

- 5 Press [◀, ▶] to select “Yes” and then press [ENTER].

- 6 Press [◀, ▶] to select “Start” and then press [ENTER].

- Creating a Top Menu starts. You cannot cancel “Create Top Menu”.
- “Create Top Menu” can take a few minutes.

- 7 Press [ENTER].

- Recording or editing on the disc may delete the menu. In that case create the menu again.
- You cannot use the title menu for playing on this unit.

## Format Disc

### RAM -RW(V) +RW

### +R +R DL (New discs only)

- Follow steps 1 to 3 of “DVD Management”. (→ 54)

Formatting deletes all contents (including computer data) and they cannot be restored. Check carefully before proceeding. The contents are deleted when you format a disc even if you have set protection.

- 4 Press [▲, ▼] to select “Format Disc” and then press [ENTER].

- 5 Press [◀] to select “Yes” and then press [ENTER].

e.g., RAM

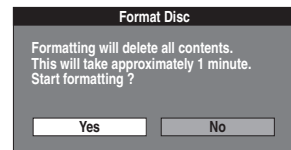

- 6 Press [◀] to select “Start” and then press [ENTER].

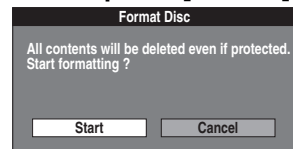

- Formatting starts.
- A message appears when formatting is finished.

### Notes

- Formatting normally takes a few minutes. (RAM However it may take up to a maximum of 70 minutes.)
- Do not disconnect the AC mains lead while formatting. This can render the disc unusable.

- 7 Press [ENTER].

### To stop formatting RAM

Press [RETURN].

- You can cancel formatting if it takes more than 2 minutes. The disc must be reformatted if you do this.

### Notes

- When a disc has been formatted using this unit, it may not be possible to use it on other equipment.
- DVD-R, DVD-R DL and CD-R/RW cannot be formatted.
- You can only format DVD-RW in the DVD-Video format on this unit.
- RAM The disc cannot be formatted if the write-protect tab (→ 55) is switched to “PROTECT”. Release the protection to continue.
- When it is not possible for the unit to format the disc, the message “Unable to format” is displayed.

## Finalize

**-R -R DL -RW(V) +R +R DL**

- Follow steps 1 to 3 of “DVD Management”. (→ 54)
- Select “Top Menu” or “Title 1” from “Auto-Play Select” before finalizing the disc. (→ 55)

You can play DVD-R, DVD-R DL, DVD-RW (DVD-Video format), +R or +R DL on compatible DVD players after finalizing it on this unit, effectively making it into a DVD-Video that complies with DVD-Video standards. The menu you create with the unit can also be used on DVD players.

- 4 Press [**▲**, **▼**] to select “Finalize” and then press [ENTER].
- 5 Press [**◀**] to select “Yes” and then press [ENTER].

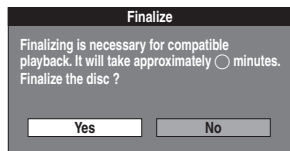

- 6 Press [**◀**] to select “Start” and then press [ENTER].

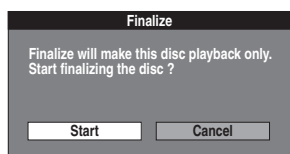

- Finalizing starts.
- You cannot cancel finalizing.
- A message appears when finalizing is finished.

### Notes

- Finalizing can take a few minutes or up to a maximum of 15 minutes, depending on the remaining space on the disc. (**-R DL +R DL** Finalizing can take up to 60 minutes.)
- **Do not disconnect the AC mains lead while finalizing.** This can render the disc unusable.

- 7 Press [ENTER].

### Notes

- When finalizing a high-speed recording compatible disc, it may take longer than displayed on the confirmation screen (approximately 4 times longer).
  - After finalizing
    - **-R -R DL +R +R DL** The disc becomes play-only and you can no longer record or edit it.
    - **-RW(V)** Although DVD-RW (DVD-Video format) becomes play-only after finalizing, you can record and edit the disc after re-formatting it. (→ 55)
    - DVD-R, DVD-R DL, DVD-RW (DVD-Video format), +R or +R DL finalized on the unit may not be playable on other players depending on the condition of the recording.
    - There is a pause of several seconds between titles and chapters during play.
    - Titles are divided into about 5-minute chapters\*. (**-R DL +R DL** 8 minutes.)
- \* This time varies greatly depending on the condition and mode of recording.

## Close First Layer

**-R DL +R DL**

### Preparation

- Insert a disc (→ 17).
- Press [DRIVE SELECT] to select the DVD drive.

- Follow steps 1 to 3 of “DVD Management”. (→ 54)

DVD-R DL and +R DL discs have two layers of recordable surfaces on one side. This unit does not offer seamless recording between the two layers. Recording stops when space on the first layer is full. The first layer must be closed to start recording on the second layer. Closing the first layer makes it unavailable for recording (editing is still possible). You cannot cancel closing. Make certain before proceeding.

- 4 Press [**▲**, **▼**] to select “Close First Layer” and then press [ENTER].
- 5 Press [**◀**] to select “Yes” and then press [ENTER].
- 6 Press [**◀**] to select “Start” and then press [ENTER].

- Closing the layer starts. You cannot cancel closing.

- Closing a layer can take a few minutes or up to a maximum of 30 minutes, depending on the remaining space on the disc.

### Note

- **Do not disconnect the AC mains lead while closing.** This can render the disc unusable.

- 7 Press [ENTER].

### To confirm the layer you can record

You can confirm the remaining recording time on the layer you can record.

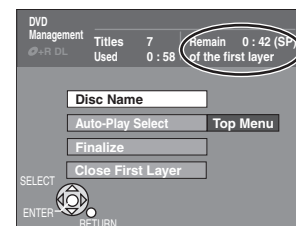

### Notes

- You cannot close the first layer when there are no recordings on it.
- By closing the first layer, you can record or edit discs that have been recorded on the second layer by other equipment.



# Changing the unit's settings

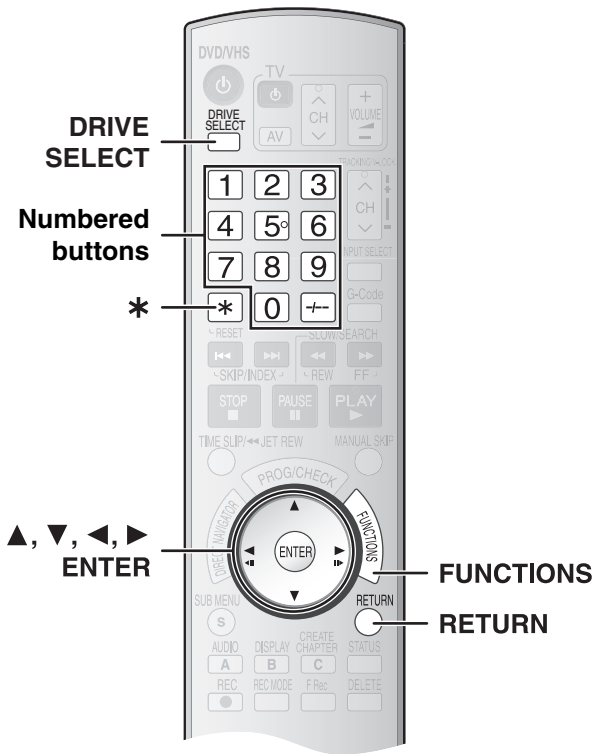

## Entering a password (Ratings)

You can limit play of DVDs unsuitable for some audiences (e.g., children). Play and changes to the settings are not possible unless you enter a password.

### When setting ratings (→ below)

The password screen is shown when you select levels 0 to 7.

- 1 Input a 4-digit password with the numbered buttons.
  - If you enter the wrong number, press [◀] to delete a digit at a time or press [\*] to delete all the digits before you press [ENTER].
  - **Do not forget your password.**

- 2 Press [ENTER].

- 3 Press [ENTER] again.

The password is entered and the unit is locked.

A message appears on the TV when you insert a DVD-Video that exceeds the ratings limit you set.

Follow the on-screen instructions.

### When changing ratings (→ below)

The password screen is shown when you select "Ratings".

- 1 Input a 4-digit password with the numbered buttons and press [ENTER].

- Unlock Recorder:** To unlock the unit and return the rating to level 8
- Change Password:** To change the password
- Change Level:** To change the rating level
- Temporary Unlock:** To temporarily unlock the unit (the unit locks again if you switch it to standby or open the disc tray)

- 2 Select a desired item with [▲, ▼], press [ENTER] and then follow the on-screen instructions.

## Summary of settings

This description shows the initial settings for the unit. For details on menu operation. → left

- Underlined items are the factory default settings.

### ■ Tuning

Manual (→ 60)

Auto-Setup Restart (→ 61)

### ■ Disc

#### Settings for Playback

Press [ENTER] to show the following settings.

#### Ratings (→ Above)

Set a ratings level to limit DVD-Video play.

#### Setting ratings (When level 8 is selected)

[8 No Limit]: All DVD-Video can be played.

[1] to [7]: Prohibits play of DVD-Video with corresponding ratings recorded on them.

[0 Lock All]: Prohibits play of all DVD-Video.

#### Changing ratings (When level 0 to 7 is selected)

[Unlock Recorder] [Change Password]

[Change Level] [Temporary Unlock]

#### DVD-Audio Video mode Playback

Select "On" to play the DVD-Video content on some DVD-Audio.

[On] [Off]

<b>On</b>	The setting returns to "Off" when you change the disc or turn the unit off.
-----------	---

#### Soundtrack

[English] [German] [French] [Italian] [Spanish] [Original]

[Other \*\*\*\*\*]

#### Subtitle

[Automatic] [English] [German] [French] [Italian]

[Spanish] [Other \*\*\*\*\*]

#### Menus

[English] [German] [French] [Italian] [Spanish]

[Other \*\*\*\*\*]

## Common procedures

Use the following procedure to change the settings if necessary.

- 1 While stopped

Press [FUNCTIONS].

- 2 Press [▲, ▼] to select "To Others" and then press [ENTER].

- 3 Press [▲, ▼] to select "Setup" and then press [ENTER].

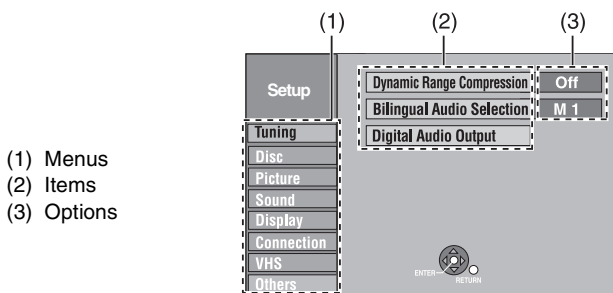
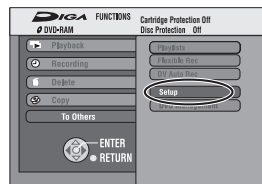

- (1) Menus
- (2) Items
- (3) Options

- 4 Press [▲, ▼] to select a menu and then press [◀, ▶].

- 5 Press [▲, ▼] to select an item to be changed and then press [ENTER].

- 6 Press [▲, ▼] to select an option and then press [ENTER].

- Some options require different operations. Follow the displayed instructions.

### ■ To return to the previous screen

Press [RETURN].

- Even if you have changed an option, the change is not activated until you press [ENTER].

### ■ To exit the screen

Press [RETURN] several times.

### For your reference

- The settings remain intact even if you switch the unit to standby.

• Underlined items are the factory default settings.

**DVD-V** Choose the language for audio, subtitles and disc menus.

• If a language which is not recorded is selected, or if languages are already fixed on the disc, the language set as the default on the disc will be played instead.

**Original**

The original language of each disc will be selected.

**Other \*\*\*\***

This is the language code setting.

Input a code number with the numbered buttons. (→ 59, Language code list)

**Automatic**

If the language selected for "Soundtrack" is not available, subtitles of that language will automatically appear if available on the disc.

**Settings for recording**

Press [ENTER] to show the following settings.

**Recording time in EP mode**

Select the maximum number of hours for recording in EP mode (→ 19, Recording modes and approximate recording times).

[EP ( 6Hours )] [EP ( 8Hours )]

<b>EP ( 6Hours )</b>	You can record for 6 hours on an unused 4.7 GB disc.
<b>EP ( 8Hours )</b>	You can record for 8 hours on an unused 4.7 GB disc.

**Picture**

**Comb Filter**

Select the picture sharpness when recording.

The setting is fixed to "On" if you set "TV System" (→ 59) to "NTSC".

[On] [Off]

<b>On</b>	Pictures become clear and vivid. Normally, use this setting.
<b>Off</b>	Select it when recording noisy pictures.

**Still Mode**

Select the type of picture shown when you pause play.

(→ 62, Frame and field)

[Automatic] [Field] [Frame]

<b>Field</b>	Select if jittering occurs when "Automatic" is selected.
<b>Frame</b>	Select if you cannot see small text or fine patterns clearly when "Automatic" is selected.

**Sound**

**Dynamic Range Compression**

**DVD-V** (Dolby Digital only)

Change the dynamic range (→ 62) for easier listening in low volume.

[On] [Off]

**Bilingual Audio Selection**

Select whether to record the main or secondary audio type when recording or transferring (copying) to DVD-R, DVD-R DL, DVD-RW (DVD-Video format) +R, +R DL or +RW. You cannot select the audio when recording from an external device. Select it on the external device. (Except for DV equipment connected to this unit's DV IN terminal.)

[M 1] [M 2]

**Digital Audio Output**

Change the settings when you have connected equipment through the unit's DIGITAL AUDIO OUT terminal (→ 13).

Press [ENTER] to show the following settings.

**Note**

Incorrect settings can cause noise, which can be harmful to your ears and speakers to be output and the audio will not be recorded properly on media such as mini discs.

**PCM Down Conversion**

Select how to output audio that has a sampling frequency of 96 kHz or 88.2 kHz.

• Signals are converted to 48 kHz or 44.1 kHz despite the above settings if the signals have a sampling frequency of over 96 kHz or 88.2 kHz, or the disc has copy protection.

[On] [Off]

<b>On</b>	Signals are converted to 48 kHz or 44.1 kHz. (Choose when the connected equipment cannot process signals with sampling frequency of 96 kHz or 88.2 kHz.)
<b>Off</b>	Signals are output as 96 kHz or 88.2 kHz. (Choose when the connected equipment can process signals with sampling frequency of 96 kHz or 88.2 kHz.)

**Dolby Digital**

Choose whether to output by "Bitstream" which processes Dolby Digital signals on other connected equipment or to convert the signals to "PCM" (2 channels) on the unit before output.

[Bitstream] [PCM]

<b>Bitstream</b>	When you have connected the unit to a piece of equipment with the Dolby Digital logo.
<b>PCM</b>	When you have connected the unit to a piece of equipment without the Dolby Digital logo.

**DTS**

Choose whether to output by "Bitstream" which processes DTS signals on other connected equipment or to convert the signals to "PCM" (2 channels) on the unit before output.

[Bitstream] [PCM]

<b>Bitstream</b>	When you have connected the unit to a piece of equipment with the DTS logo.
<b>PCM</b>	When you have connected the unit to a piece of equipment without the DTS logo.

**MPEG**

Choose whether to output by "Bitstream" which processes MPEG signals on other connected equipment or to convert the signals to "PCM" (2 channels) on the unit before output.

[Bitstream] [PCM]

<b>Bitstream</b>	When you have connected the unit with a built-in MPEG decoder.
<b>PCM</b>	When you have connected the unit without a built-in MPEG decoder.

**Audio Mode for DV Input**

You can select the kind of audio when recording from the unit's DV IN terminal.

[Stereo 1] [Stereo 2] [Mix]

<b>Stereo 1</b>	Records audio (L1, R1)
<b>Stereo 2</b>	Records added audio such as narration (L2, R2) subsequent to the original recording.
<b>Mix</b>	Records both Stereo 1 and Stereo 2

**-R -R DL -RW(V) +R +R DL +RW**

When recording bilingual broadcasts to a disc, select the type of audio in advance at "Bilingual Audio Selection" → left.

**Display**

**On-Screen Messages**

Choose whether to show status messages automatically or not.

[Automatic] [Off]

**Grey Background**

Select whether to show the grey background, normally shown when TV reception is poor.

[On] [Off]

**FL Display**

Changes the brightness of the unit's display.

[Bright] [Dim] [Automatic]

<b>Automatic</b>	The display turns dark during play and reappears momentarily if a button is pressed. When the unit is turned off, the unit's display disappears. While using this mode the standby power consumption can be reduced.
------------------	--

• When "Power Save" is set to "On" (→ 59), this setting is automatically fixed to "Automatic".

• Underlined items are the factory default settings.

### ■ Connection

#### TV Aspect (→ 15)

[16:9] [4:3] [Letterbox]

#### Progressive (→ 16)

[On] [Off]

<b>On</b>	Select when connecting to an LCD or plasma television with component video input terminals.
<b>Off</b>	Select when connecting to a regular television (CRT: Cathode Ray Tube) even if it is progressive compatible.

### TV System

[PAL] [NTSC]

<b>PAL</b>	Select when connecting to a PAL or Multi-system TV. Programmes recorded using NTSC are played as PAL 60. Select to record TV programmes and PAL input from other equipment.
<b>NTSC</b>	Select when connecting to a NTSC TV. Programmes recorded using NTSC are played as NTSC. Select to record NTSC input from other equipment. TV programmes cannot be recorded properly on DVD.

• To change the TV system (PAL/NTSC) setting:

While stopped, press and hold [■] and [▲, OPEN/CLOSE] on the main unit for 5 seconds or more.

### ■ VHS

#### Tape Length

Set the length of the tape you are using so the unit can show the correct remaining time.

[Auto (E-240)] [E-195] [E-260] [E-300]

<b>Auto (E-240)</b>	The VHS automatically distinguishes E30, -60, -90, -120, -180 and -240 tapes.
<b>E-195</b>	For E195 tape
<b>E-260</b>	For E260 tape
<b>E-300</b>	For E300 tape

### Playback Colour System **For Asia and the Middle East**

[Automatic] [PAL] [MESECAM]

### SQPB

To play back video cassettes recorded in the S-VHS format (SQPB; S-VHS Quasi Playback)

[Automatic] [On] [Off]

<b>Automatic</b>	This unit automatically detects the format in which the recording was made and selects the same format for playback. However, picture distortion may appear. Therefore, set to [On] or [Off].
<b>On</b>	Use this setting when playing back a cassette tape recorded in the S-VHS format.
<b>Off</b>	Use this setting when playing back a cassette tape recorded in the VHS format only.

### Language code list

Abkhazian: 6566	Chinese: 9072	Hausa: 7265	Lithuanian: 7684	Romanian: 8279	Telugu: 8469
Afar: 6565	Corsican: 6779	Hebrew: 7387	Macedonian: 7775	Russian: 8285	Thai: 8472
Afrikaans: 6570	Croatian: 7282	Hindi: 7273	Malagasy: 7771	Samoan: 8377	Tibetan: 6679
Albanian: 8381	Czech: 6783	Hungarian: 7285	Malay: 7783	Sanskrit: 8365	Tigrinya: 8473
Ameharic: 6577	Danish: 6865	Icelandic: 7383	Malayalam: 7776	Scots Gaelic: 7168	Tonga: 8479
Arabic: 6582	Dutch: 7876	Indonesian: 7378	Maltese: 7784	Serbian: 8382	Turkish: 8482
Armenian: 7289	English: 6978	Interlingua: 7365	Maori: 7773	Serbo-Croatian: 8372	Turkmen: 8475
Assamese: 6583	Esperanto: 6979	Irish: 7165	Marathi: 7782	Shona: 8378	Twí: 8487
Aymara: 6589	Estonian: 6984	Italian: 7384	Moldavian: 7779	Sindhi: 8368	Ukrainian: 8575
Azerbaijani: 6590	Faroese: 7079	Japanese: 7465	Mongolian: 7778	Singhalese: 8373	Urdu: 8582
Bashkir: 6665	Fiji: 7074	Javanese: 7487	Nauru: 7865	Slovak: 8375	Uzbek: 8590
Basque: 6985	Finnish: 7073	Kannada: 7578	Nepali: 7869	Slovenian: 8376	Vietnamese: 8673
Bengali, Bangla: 6678	French: 7082	Kashmiri: 7583	Norwegian: 7879	Somali: 8379	Volapük: 8679
Bhutani: 6890	Frisian: 7089	Kazakh: 7575	Oriya: 7982	Spanish: 6983	Welsh: 6789
Bihari: 6672	Galician: 7176	Kirghiz: 7589	Pashto, Pushto: 8083	Sundanese: 8385	Wolof: 8779
Breton: 6682	Georgian: 7565	Korean: 7579	Persian: 7065	Swahili: 8387	Xhosa: 8872
Bulgarian: 6671	German: 6869	Kurdish: 7585	Polish: 8076	Swedish: 8386	Yiddish: 7473
Burmese: 7789	Greek: 6976	Laotian: 7679	Portuguese: 8084	Tagalog: 8476	Yoruba: 8979
Byelorussian: 6669	Greenlandic: 7576	Latin: 7665	Punjabi: 8065	Tajik: 8471	Zulu: 9085
Cambodian: 7577	Guarani: 7178	Latvian, Lettish: 7686	Quechua: 8185	Tamil: 8465	
Catalan: 6765	Gujarati: 7185	Lingala: 7678	Rhaeto-Romance: 8277	Tatar: 8484	

### ■ Others

#### Remote Control (→ 15)

[DVD 1] [DVD 2] [DVD 3]

#### Clock (→ 61)

#### Power Save

[On] [Off]

<b>On</b>	The power consumption is greatly reduced when the unit is turned off. • "FL Display" (→ 58) is automatically set to "Automatic". • The "Quick Start" (→ below) function does not work. (It is automatically set to "Off".) • The power save function is not activated when either DVD or VHS is in the standby mode.
<b>Off</b>	The power consumption is not reduced when the unit is turned off.

• If "Quick Start" is set to "On", "Power Save" is automatically turned to "Off".

#### Quick Start

[On] [Off]

<b>On</b>	1 Sec. Quick Start for Recording on DVD-RAM. From the power off state, recording on DVD-RAM starts about 1 second after first pressing the [⏪, DVD/VHS] and then sequentially pressing the [●, REC] (Quick Start Mode). Power consumption is also higher when the unit is turned off if this is set to "On".
-----------	--

• If this is set to "On", "Power Save" is automatically turned to "Off".

#### Country (→ 14) **For Australia and New Zealand**

[Australia] [New Zealand] [Others]

#### DivX Registration (→ 29)

Displays the unit's registration code. You need this registration code to purchase and play DivX Video-on-Demand (VOD).

#### Initialize

Press [ENTER] to show the following settings.

#### Shipping Condition

All the settings except for the ratings level, the password and the time settings return to the factory preset. The timer recording programmes are also cancelled.

[Yes] [No]

#### Default Settings

All the settings other than the programmed channels, time settings, country settings, disc language settings\*, ratings level, password and remote control code return to the factory presets.

[Yes] [No]

\* **For Australia and New Zealand**

# Resetting the channel setting

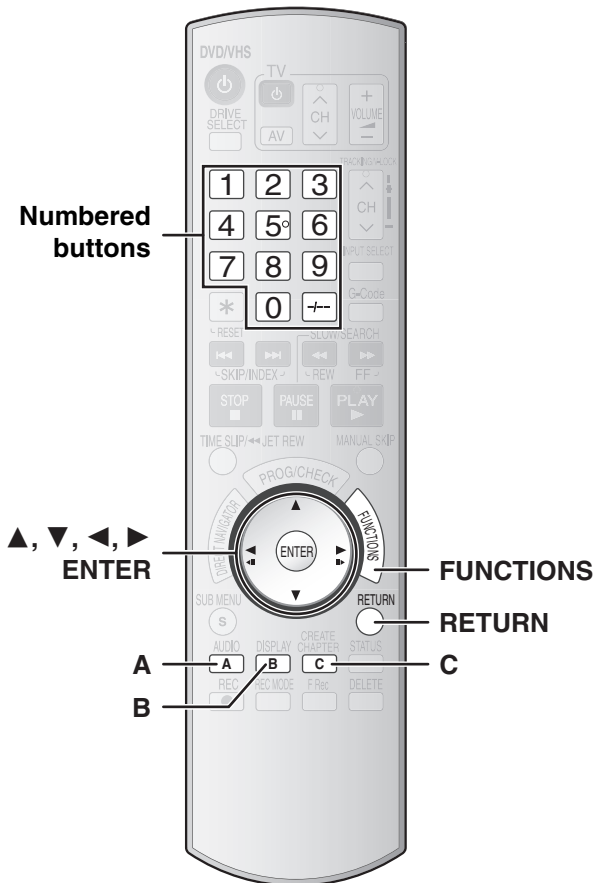

## Tuning

- 1 While stopped Press [FUNCTIONS].
- 2 Press [▲, ▼] to select "To Others" and then press [ENTER].
- 3 Press [▲, ▼] to select "Setup" and then press [ENTER].
- 4 Press [▲, ▼] to select "Tuning" and then press [◀, ▶].

### Manual

You can add or delete channels or the change programme positions.

- 5 Press [▲, ▼] to select "Manual" and then press [ENTER].

To delete a programme position

Press [◀, ▶, ▲, ▼] to select a programme position and then press [A].

To add a blank programme position

Press [◀, ▶, ▲, ▼] to select a programme position and then press [B].

To move a TV station to another programme position

- ① Press [◀, ▶, ▲, ▼] to select the programme position and then press [C].
- ② Press [▲, ▼] to select the new programme position to which you want to assign the TV station and then press [ENTER].

### To change detailed station settings

Follow steps 1 to 5, → left.

- 6 Press [◀, ▶, ▲, ▼] to select a programme position and then press [ENTER].

Press [▲, ▼] to select an item and then press [▶].

<b>Pos</b>	<b>To change the programme position in which the TV stations are assigned</b> Press [▲, ▼] or the numbered buttons to select the number of the desired programme position and then press [ENTER].
<b>Name</b>	<b>To enter or change the name of a TV station</b> Press [▲, ▼] to enter the station name and then press [ENTER]. If the station name needs a blank space, select the blank between "Z" and "X".
<b>Channel</b>	<b>To enter newly available TV stations or change the channel number of an already tuned TV station</b> Press [▲, ▼] or the numbered buttons to enter the channel number of the desired TV station. Wait a few moments until the desired TV station has been tuned. After the desired TV station is tuned, press [ENTER].
<b>Fine Tuning</b>	<b>To obtain the best tuning condition</b> Press [▲, ▼] to adjust the best tuning condition and then press [ENTER]. Press [▶] to return to "Auto".
<b>Video System*</b>	<b>To select the video system type</b> Press [▲, ▼] to select "PAL" or "SECAM" if the picture lacks colour and then press [ENTER]. Auto: This unit automatically distinguishes PAL and SECAM signals. PAL: For receiving PAL signals. SECAM: For receiving SECAM signals. • This setting is also available when you select the external input channel (AV1, AV2 or DV IN) in step 5. In order to record properly make sure the appropriate setting to match the connected equipment.
<b>Audio Mode*</b>	<b>To select the audio reception type</b> Press [▲, ▼] to select the items and then press [ENTER], if the sound quality is poor. BG: PAL B.G I: PAL I DK: PAL D.K.K1
<b>Mono</b>	To select the type of sound to be recorded Press [▲, ▼] to select "On" and then press [ENTER], if the stereo sound is distorted due to inferior reception conditions or if you want to record the normal (mono) sound during a stereo, bilingual or NICAM broadcast.

\* For the Middle East

#### To exit the screen

Press [RETURN] several times.

#### To return to the previous screen

Press [RETURN].

## Automatic setting

You can restart auto channel setting if the channel reception setting (→ 14) fails for some reason.

- 1 While stopped  
Press [FUNCTIONS].
- 2 Press [▲, ▼] to select “To Others” and then press [ENTER].
- 3 Press [▲, ▼] to select “Setup” and then press [ENTER].
- 4 Press [▲, ▼] to select “Tuning” and then press [◀, ▶].
- 5 Press [▲, ▼] to select “Auto-Setup Restart” and then press [ENTER].

### For Australia and New Zealand

- Press [▲, ▼] to select the country and then press [ENTER].

You can also use the following method to restart Auto-Setup.

When the unit is on and stopped,

**Press and hold [CH, v] and [CH, ^] on the main unit until the Country setting screen or the Auto-Setup screen appears.**

- All the settings except for the ratings level, password and time settings return to the factory preset. The timer recording programmes are also cancelled.

### To exit the screen

Press [RETURN] several times.

### To return to the previous screen

Press [RETURN].

### List of TV Reception Channels

#### For Asia and the Middle East

Tuner System	Channel Coverage	VHF	UHF	CATV
PAL-DK SECAM-DKK1	OIRT	R1 - R12	CH 21 - 69	44 MHz - 470 MHz
PAL-BGH, SECAM-BG	CCIR	E2 - E12	E21 - E69	S01 - S05, M1 - M10, U1 - U10, S21 - S41
PAL-D	China	CH 1 - 12	CH 13 - 57	-

#### For Australia and New Zealand

Tuner System	Channel Coverage	VHF	UHF	CATV
PAL-B	Australia	0-12	28-69	45 MHz - 470 MHz
PAL-BG	New Zealand	1-11	21-69	44 MHz - 470 MHz

## Set the clock manually

- In the case of power failure the clock setting remains in the memory for approximately 60 minutes.

- 1 While stopped  
Press [FUNCTIONS].
- 2 Press [▲, ▼] to select “To Others” and then press [ENTER].
- 3 Press [▲, ▼] to select “Setup” and then press [ENTER].
- 4 Press [▲, ▼] to select “Others” and then press [▶].
- 5 Press [▲, ▼] to select “Clock” and then press [ENTER].
- 6 Press [◀, ▶] to select the item you want to change and then press [▲, ▼] to change the setting.

The items change as follows:

Hour↔Minutes↔Second↔Day↔Month↔Year

↑

- You can also use the numbered buttons for setting.

- 7 Press [ENTER] when you have finished the settings.  
The clock starts.

### To exit the screen

Press [RETURN] several times.

### To return to the previous screen

Press [RETURN].

## Bitstream

This is a signal compressed and converted into digital form. It is converted back to a multi-channel audio signal, e.g., 5.1-channel, by a decoder.

## Component video output

Component signal outputs the colour difference signals (PB/PR) and luminance signal (Y) separately in order to achieve high fidelity in reproducing colours. If the television is compatible with progressive output, a high quality picture can be output because this unit's component video output terminal outputs a progressive output signal.

## CPRM (Content Protection for Recordable Media)

CPRM is technology used to protect broadcasts that are allowed to be recorded only once. Such broadcasts can be recorded only with CPRM compatible recorders and discs.

## Decoder

A decoder restores the coded audio signals on DVDs to the state they were before being encoded.

## DivX

DivX is a popular media technology created by DivX, Inc. DivX media files contain highly compressed video with high visual quality that maintains a relatively small file size.

## Dolby Digital

This is a method of coding digital signals developed by Dolby Laboratories. Apart from stereo (2-channel) audio, these signals can also be multi-channel audio. A large amount of audio information can be recorded on one disc using this method.

## Down-mixing

This is the process of remixing the multi-channel audio found on some discs into two channels. It is useful when you want to listen to the 5.1-channel audio recorded on DVDs through your TV's speakers. Some discs prohibit down-mixing. If this is the case, this unit can only output the front two channels.

## DTS (Digital Theater System)

This surround system is used in many movie theaters. There is good separation between the channels so realistic sound effects are possible.

## Dynamic range

Dynamic range is the difference between the lowest level of sound that can be heard above the noise of the equipment and the highest level of sound before distortion occurs. Dynamic range compression means reducing the gap between the loudest and softest sounds. This means you can hear the dialogue clearly at low volume.

## Film and Video

DVD-Videos are recorded using either film or video. The unit can determine which type has been used, then uses the most suitable method of progressive output.

For PAL

- Film is 25 frames per second.
- Video is 50 fields per second (2 fields making up 1 frame).

For NTSC

- Film is 24 or 30 frames per second, with motion picture film generally being 24 frames per second.
- Video is 60 fields per second (2 fields making up 1 frame).

## Finalize

A process that makes play of a recorded CD-R, CD-RW, DVD-R, etc. possible on equipment that can play such media. You can finalize DVD-R, DVD-R DL, DVD-RW (DVD-Video format), +R and +R DL on the unit. After finalizing, the disc becomes play-only and you can no longer record or edit. However, finalized DVD-RW can be formatted to become recordable.

## Formatting

Formatting is the process of making media such as DVD-RAM recordable on recording equipment.

You can format DVD-RAM, DVD-RW (only as DVD-Video format), +R, +R DL and +RW on the unit.

Formatting irrevocably deletes all contents on the disc.

## Frame and field

A Frame is a single image on the TV. Each frame consists of 2 fields.

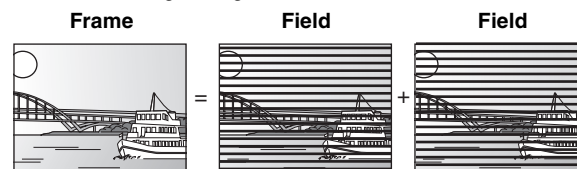

- A still frame shows 2 fields, so there may be some blurring between them, but picture quality is generally better.
- A still field shows less picture information so it may be rougher, but there is no blurring.

## JPEG (Joint Photographic Experts Group)

This is a system used for compressing/decoding colour still pictures. If you select JPEG as the storage system on digital cameras, etc., the data will be compressed to 1/10–1/100 of its original size. The benefit of JPEG is less deterioration in picture quality considering the degree of compression.

## MP3 (MPEG Audio Layer 3)

A method that compresses audio to approximately a tenth of its size without any considerable loss to audio quality. You can play MP3s that you have recorded onto CD-R and CD-RW.

## Pan & Scan/Letterbox

In general, DVD-Videos are produced with the intention that they will be viewed on a widescreen TV (16:9 aspect ratio), so images often do not fit regular TVs (4:3 aspect ratio). 2 styles of picture, "Pan & Scan" and "Letterbox", deal with this problem.

Pan & Scan: The sides are cut off so the picture fills the screen.



Letterbox: Black bands appear at the top and bottom of the picture so the picture itself appears in an aspect ratio of 16:9.



## Playback control (PBC)

If a Video CD has playback control, you can select scenes and information with menus displayed on the screen.

(The unit is compatible with version 2.0 and 1.1.)

## Progressive/Interlace

The PAL video signal standard has 576 (or 625) interlaced (i) scan lines, whereas progressive scanning, called 576p (or 625p), uses twice the number of scan lines. For the NTSC standard, these are called 480i (or 525i) and 480p (or 525p) respectively.

Using progressive output, you can enjoy the high-resolution video recorded on media such as DVD-Video.

Your television must be compatible to enjoy progressive video.

Panasonic televisions with 576 (625)/50i · 50p, 480 (525)/60i · 60p input terminals are progressive compatible.

## Protection

You can prevent accidental erasure by setting write-protection or erasure protection.

## Sampling frequency

Sampling is the process of converting the heights of sound wave (analogue signal) samples taken at set periods into digits (digital encoding). Sampling frequency is the number of samples taken per second, so larger numbers mean more faithful reproduction of the original sound.

## Thumbnail

This refers to a miniature representation of a picture used to display multiple pictures in the form of a list.

## TIFF (Tag Image File Format)

This is a still picture data standard. A common format for storing high quality images on digital cameras and other devices.



# Error messages

## On the television

		Page
<b>Authorization Error</b>	<ul style="list-style-type: none"> <li>You are trying to play a DivX VOD contents that was purchased with a different registration code. You cannot play the contents on this unit.</li> </ul>	29
<b>Cannot finish recording completely.</b>	<ul style="list-style-type: none"> <li>The programme was copy-protected.</li> <li>The disc may be full.</li> <li>The maximum number of times you can record the programme is exceeded.</li> <li><b>RAM -R -R DL -RW(V)</b> There are already 99 recorded titles (<b>+R +R DL +RW</b> 49 recorded titles).</li> </ul>	– – – –
<b>Cannot playback. TV system is different from the setting. To playback, please change the TV System in Setup.</b>	<ul style="list-style-type: none"> <li>You tried to play a title recorded using a different encoding system from that of the TV system currently selected on the unit. Alter the “TV System” setting on this unit to suit.</li> </ul>	59
<b>Unable to format.</b>	<ul style="list-style-type: none"> <li>The disc may be dirty or scratched.</li> </ul>	8
<b>Please check the disc.</b>		
<b>Cannot record. Disc is full.</b>	<ul style="list-style-type: none"> <li><b>RAM -RW(V) +RW</b> Create space by deleting any unwanted titles. Even if you delete recorded content from the DVD-R or +R, there is no increase in disc space. Available recording space on a DVD-RW (DVD-Video format) or +RW increases when the title recorded last is deleted. (The recording space may increase slightly when other titles are deleted.)</li> <li>Use a new disc.</li> </ul>	27, 53
<b>Cannot record. Maximum number of titles exceeded.</b>		–
<b>Cannot record to the disc. TV system of the disc is different to the setting in Setup.</b>	<ul style="list-style-type: none"> <li>The disc contains video contents of a different video system. Change the “TV System” settings in the Setup menu.</li> </ul>	59
<b>Error has occurred. Please press ENTER.</b>	<ul style="list-style-type: none"> <li>Press [ENTER] to start recovery process. You cannot operate the unit while it is recovering (“U88” appears on the unit’s display).</li> </ul>	–
<b>No Disc</b>	<ul style="list-style-type: none"> <li>You have not inserted a disc. Correctly insert a disc that the unit can play.</li> </ul>	17
<b>No cassette.</b>	<ul style="list-style-type: none"> <li>A video cassette is not inserted when recording programmes. Insert a video cassette with an accidental erasure prevention tab.</li> </ul>	17
<b>Now recording on DVD. To watch pictures on VHS, use DVD/VHS COMMON OUT, and switch to an appropriate AV channel on your TV.</b>	<ul style="list-style-type: none"> <li>It is possible to playback the VHS while recording on DVD. You can watch the VHS by connecting the unit to the TV with the DVD/VHS COMMON terminals.</li> </ul>	12
<b>Please set clock.</b>	<ul style="list-style-type: none"> <li>The clock is not set. Set the clock.</li> </ul>	61
<b>The cassette is write-protected.</b>	<ul style="list-style-type: none"> <li>A video cassette without a secure accidental erasure prevention tab is inserted when recording programmes. Use a video cassette with a secure accidental erasure prevention tab.</li> </ul>	17
<b>This is a non-recordable disc. Cannot record.</b>	<ul style="list-style-type: none"> <li>The unit cannot record on the disc you inserted. Insert a DVD-RAM or unfinalized DVD-R, DVD-R DL, DVD-RW (DVD-Video format), +R, +R DL or +RW.</li> <li>You inserted an unformatted DVD-RAM, DVD-RW, +R, +R DL or +RW. Format the disc with the unit.</li> </ul>	6
<b>This disc is not formatted properly.</b>		55
<b>To watch pictures on VHS, use DVD/VHS COMMON OUT, and switch to an appropriate AV channel on your TV.</b>	<ul style="list-style-type: none"> <li>The TV system set on the unit and the signal of the video contents of the video cassette being played is different. Connect the unit to the TV with the DVD/VHS COMMON terminals.</li> </ul>	12
<b>Rental Expired</b>	<ul style="list-style-type: none"> <li>The DivX VOD contents has zero remaining plays. You cannot play it.</li> </ul>	29
<b>Video system of the disc is different.</b>	<ul style="list-style-type: none"> <li>The input signal is different from the settings of this unit. Change the “TV System” settings in the Setup menu.</li> </ul>	59
⊘	<ul style="list-style-type: none"> <li>The operation is prohibited by the unit or disc.</li> </ul>	–

On the unit's display

Page

H□□, F□□ ("□□" stands for a number.)	<ul style="list-style-type: none"> <li>An error has occurred. The number following "H" or "F" depends on the status of the unit. Check the items in the "Error messages" section and the "Troubleshooting guide". If the service number still does not disappear after the check, follow the Reset procedure described below. <b>Reset procedure: ("The unit is on but cannot be operated." → 67)</b></li> <li>If the service numbers fail to clear, note the service numbers and contact a qualified service person.</li> </ul>	–
X HOLD	<ul style="list-style-type: none"> <li>The Child Lock function is activated. Press and hold [ENTER] and [RETURN] simultaneously until "X HOLD" disappears.</li> </ul>	36
DVD □ ("□" stands for a number.)	<ul style="list-style-type: none"> <li>The remote control and the main unit are using a different code. Change the code on the remote control.</li> </ul>	15
HARD ERR	<ul style="list-style-type: none"> <li>If there is no change after turning the unit on and off, consult the dealer where the unit was purchased.</li> </ul>	–
NoREAD	<ul style="list-style-type: none"> <li>The disc is dirty or badly scratched. The unit cannot record, play, or edit.</li> <li>You have used a lens cleaner and it has finished. Press [▲, OPEN/CLOSE] on the main unit to eject the disc.</li> </ul>	8 8, 17
NoERAS	<ul style="list-style-type: none"> <li>It may not be possible to delete the item due to a problem with the disc. Use a new disc.</li> </ul>	–
PLEASE WAIT ("PLEASE" and "WAIT" are alternately displayed.)	<ul style="list-style-type: none"> <li>Displayed when the unit is turned on. This is not a malfunction.</li> <li>The unit is carrying out its recovery process. You cannot operate the unit while "PLEASE WAIT" is displayed.</li> </ul>	– –
PROG FULL ("PROG" and "FULL" are alternately displayed.)	<ul style="list-style-type: none"> <li>There are already 16 timer programmes. Delete unnecessary timer programmes.</li> </ul>	25
UNSUPPORT ("UNSUP" and "PORT" are alternately displayed.)	<ul style="list-style-type: none"> <li>You have inserted a disc the unit cannot play or record.</li> </ul>	6, 7
UNFORMAT ("UNFOR" and "MAT" are alternately displayed.)	<ul style="list-style-type: none"> <li>You have inserted a new DVD-RAM, DVD-RW, +R, +R DL, +RW or a DVD-RAM, DVD-RW (DVD-Video format), +RW recorded on other equipment.</li> </ul>	55
NoCASSETTE ("NoCAS" and "SETTE" are alternately displayed.)	<ul style="list-style-type: none"> <li>You have not inserted a video cassette for the recording.</li> </ul>	17
PROTECT ("PROT" and "ECT" are alternately displayed.)	<ul style="list-style-type: none"> <li>You have inserted a video cassette without the accidental erasure prevention tab is inserted. Use a video cassette with an accidental erasure prevention tab.</li> </ul>	17
U59	<ul style="list-style-type: none"> <li>The unit is very warm. The unit switches to standby for safety reasons. Wait for about 30 minutes until the message disappears. Select a position with good ventilation when installing the unit. Do not block the cooling fan on the rear of the unit.</li> </ul>	–
U61	<ul style="list-style-type: none"> <li>There was a power failure or the AC plug was disconnected while the unit was on. The unit is carrying out its recovery process. This process restores the unit to normal operation. The unit is not broken. Wait until the message disappears.</li> </ul>	–
U88	<ul style="list-style-type: none"> <li>There was something unusual detected with the disc while recording, playing or transferring (copying), there was a power failure or the AC plug was disconnected while the unit was on. The unit is carrying out its recovery process. This process restores the unit to normal operation. The unit is not broken. Wait until the message disappears.</li> </ul>	66
U99	<ul style="list-style-type: none"> <li>The unit fails to operate properly. Press [⏻/I] on the main unit to switch the unit to standby. Now press [⏻/I] on the main unit again to turn the unit on.</li> </ul>	–

# Frequently asked questions

Set up		Page
What equipment is necessary to play multi channel surround sound?	<ul style="list-style-type: none"> <li>●DVD-Video: You can play DVD-Video multi channel surround by digitally connecting an amplifier equipped with a Dolby Digital or DTS decoder.</li> <li>●DVD-Audio: This unit plays DVD-Audio in 2 channels. You cannot play multi channel surround sound.</li> </ul>	7, 13 –
Can the headphones and speakers be directly connected to the unit?	<ul style="list-style-type: none"> <li>●You cannot directly connect them to the unit. Connect through the amplifier etc.</li> </ul>	13
The television has both S Video input terminal and component video input terminals. Which terminal should I connect with?	<ul style="list-style-type: none"> <li>●Connecting with the component video terminal provides a more vivid picture compared to connecting with the S Video terminal. If you have an LCD/plasma television or LCD projector compatible with progressive scan, connect through the component video terminals for high-quality progressive video. If you have a CRT television or a multi system television using PAL mode that is compatible with progressive scan, we cannot recommend progressive output as some flickering can occur.</li> </ul>	13
Is my television progressive output compatible?	<ul style="list-style-type: none"> <li>●All Panasonic television that have 576 (625)/50i · 50p, 480 (525)/60i · 60p input terminals are compatible. Consult the manufacturer if you have another brand of television.</li> </ul>	62

Disc		Page
Can I play DVD-Video, DVD-Audio and Video CDs bought in another country?	<ul style="list-style-type: none"> <li>●<b>For Asia</b> You cannot play DVD-Video if its region number does not include “3” or “ALL”.</li> <li>●<b>For Australia and New Zealand</b> You cannot play DVD-Video if its region number does not include “4” or “ALL”.</li> <li>●<b>For the Middle East</b> You cannot play DVD-Video if its region number does not include “2” or “ALL”.</li> </ul>	Cover
Can a DVD-Video that does not have a region number be played?	<ul style="list-style-type: none"> <li>●The DVD-Video region number indicates the disc conforms to a standard. You cannot play discs that do not have a region number.</li> </ul>	–
Please tell me about DVD-R, DVD-R DL, DVD-RW, +R, +R DL and +RW compatibility with the unit.	<ul style="list-style-type: none"> <li>●The unit records and plays DVD-R, DVD-R DL, DVD-RW (DVD-Video format), +R, +R DL and +RW and plays DVD-RW (DVD Video Recording format).</li> </ul>	6, 7
	<ul style="list-style-type: none"> <li>●The unit also records and plays high speed recording compatible discs.</li> </ul>	6
	<ul style="list-style-type: none"> <li>●After recording but before finalizing +R, +R DL discs                             <ul style="list-style-type: none"> <li>- You may not be able to play and record discs on this unit after recording them on other Panasonic products or other manufacturer’s equipment.</li> <li>- You may not be able to play and record discs on other equipment after recording them on this unit.</li> </ul> </li> <li>●After finalizing the disc, however, you will be able to play it on any DVD-Video compatible player.</li> </ul>	–
Please tell me about CD-R and CD-RW compatibility with the unit.	<ul style="list-style-type: none"> <li>●This unit plays CD-R/CD-RW discs which have been recorded in one of the following standards: CD-DA, Video CD, DivX, MP3 and still pictures (JPEG/TIFF). Close the session or finalize the disc after recording. This unit can recognize up to 300 folders (groups) and 3000 files (tracks) on a disc with MP3 or still pictures (JPEG/TIFF) and up to 300 folders and 200 files with DivX.</li> <li>●You cannot write to a CD-R or CD-RW with the unit.</li> </ul>	7, 28, 31 7

Recording		Page
Can I record from a commercially purchased video cassette or DVD?	<ul style="list-style-type: none"> <li>●Most commercially sold video cassettes and DVD are copy protected; therefore, recording is usually not possible.</li> </ul>	–
Can DVD-R, DVD-R DL, DVD-RW (DVD-Video format), +R, +R DL and +RW recorded on the unit be played on other equipment?	<ul style="list-style-type: none"> <li>●You can play on compatible equipment such as DVD players after finalizing the disc on this unit. It is not necessary to finalize +RW. However, depending on the condition of the recording, the quality of the disc and capabilities of the DVD player, play may not be possible. To enable play on other DVD players, please use “Create Top Menu” in the DVD Management menu.</li> </ul>	55, 56
Can I record digital audio signals using the unit?	<ul style="list-style-type: none"> <li>●You cannot record digital signals. The digital audio terminals on the unit are for output only. (The audio recorded from the digital video camera using the DV Auto Rec function, for example, is recorded digitally.)</li> </ul>	–
Can a digital audio signal from the unit be recorded to other equipment?	<ul style="list-style-type: none"> <li>●You can record if using the PCM signal. When recording DVD, change the “Digital Audio Output” settings to the following from the Setup menu.                             <ul style="list-style-type: none"> <li>- “PCM Down Conversion”: “On”</li> <li>- “Dolby Digital”/“DTS”/“MPEG”: “PCM”</li> </ul>                             However,                             <ul style="list-style-type: none"> <li>- As long as digital recording from the disc is permitted.</li> <li>- As long as the recording equipment is compatible with 48 kHz of sampling frequency.</li> </ul> </li> <li>●You cannot record MP3 signals.</li> </ul>	58 –
	Can I switch to bilingual broadcast during recording?	<ul style="list-style-type: none"> <li>●With DVD-RAM/video cassettes, you can. Just press [AUDIO].</li> <li>●With DVD-R, DVD-R DL, DVD-RW (DVD-Video format), +R, +R DL, +RW you cannot. Change before recording with “Bilingual Audio Selection” in the Setup menu.</li> </ul>

# Troubleshooting guide

Before requesting service, make the following checks. If you are in doubt about some of the check points, or if the remedies indicated in the chart do not solve the problem, consult your dealer.

## The following do not indicate a problem with the unit:

- Regular disc/video cassette rotating sound. The sound of the disc rotating may become louder especially when finalizing a DVD-R, DVD-R DL, DVD-RW (DVD-Video format), +R or +R DL.
- Poor reception due to atmospheric condition.
- Image disturbance during search.
- Operations do not work due to a poor-quality disc. (Try again using a Panasonic disc.)
- The unit freezes due to the activation of one of its safety devices. (Press and hold [⏻/⏪] on the main unit for 10 seconds.)

## Power

		Page
<b>No power</b>	● Insert the AC mains lead securely into a known active household mains socket.	12
<b>The unit switches to the standby mode.</b>	● One of the unit's safety devices is activated. Press [⏻/⏪] on the main unit to turn the unit on.	-

## Displays

		Page
<b>The display is dim.</b>	● Change "FL Display" in the "Setup" menu.	58
<b>"0:00" is flashing on the unit's display.</b>	● Set the clock.	61
<b>The recording time display, the transfer (copying) process display and the displayed recording time of MP3 are different from the actual time.</b>	● The time on the unit's display and the remaining recording time on the screen may be indicated less or more than the actual value.	-
	● The available recording space on DVD-R, DVD-R DL, +R or +R DL does not increase when you delete titles.	-
	● Available recording space on a DVD-RW (DVD-Video format) or +RW increases only when the title recorded last is deleted. It does not increase if other titles are deleted.	-
	● If you repeat recording or editing about 200 times or more, the remaining capacity of the DVD-R, DVD-R DL, +R or +R DL is reduced and then recording or editing may be disabled. (For the second layer on DVD-R DL and +R DL, this happens after about 60 times.)	-
	● The time during fast forward and rewind, or the process during transfer (copy) may not be displayed accurately.	-
<b>Compared to the actual recorded time, the elapsed time displayed is less (only when recording in NTSC).</b>	● The displayed recording/play time is converted from the number of frames at 29.97 frames (equal to 0.999 seconds) to one second. There will be a slight difference between the time displayed and the actual elapsed time (e.g., actual one-hour elapsed time may display as approximately 59 minutes 56 seconds). This does not affect the recording.	-
<b>The tape counter is not changing.</b>	● The tape counter does not change while playing unrecorded parts. The "second" display changes as follows: (e.g., Blank after 1 h 36 min)	-
	 ● The unit's display also appears like this if the tape is dirty or damaged. Consult your dealer if this is the case.	-
<b>"U88" is displayed and the disc cannot be ejected.</b>	● The unit is carrying out the recovery process. Do the following to eject the disc. (1) Press [⏻/⏪] on the main unit to switch the unit to standby. If the unit does not switch to standby, press and hold [⏻/⏪] on the main unit for about 10 seconds. The unit is forcibly switched to standby. (2) While the unit is off, press and hold [■] and [CH, ^] on the main unit at the same time for about 5 seconds. Remove the disc.	-

Operation		Page
Cannot operate the TV.	<ul style="list-style-type: none"> <li>Change manufacturer code. Some TVs cannot be operated even if you change the code.</li> </ul>	15
Cannot operate the DVD.	<ul style="list-style-type: none"> <li>Press [DRIVE SELECT] to select the DVD.</li> </ul>	10
Cannot operate the VHS.	<ul style="list-style-type: none"> <li>Press [DRIVE SELECT] to select the VHS.</li> </ul>	10
The remote control does not work.	<ul style="list-style-type: none"> <li>The remote control and main unit are using different codes. Change the code on the remote control.</li> </ul>	15
	<ul style="list-style-type: none"> <li>Press and hold [ENTER] and the indicated number button at the same time for more than 2 seconds.</li> </ul>	15
	<ul style="list-style-type: none"> <li>The batteries are depleted. Replace them with new ones.</li> </ul>	10
	<ul style="list-style-type: none"> <li>It may be necessary to reset the code on the remote control again after changing the batteries.</li> </ul>	10
	<ul style="list-style-type: none"> <li>Point the remote control at the remote control sensor on the main unit.</li> </ul>	10
	<ul style="list-style-type: none"> <li>Remove obstacles between the remote control and main unit.</li> </ul>	10
	<ul style="list-style-type: none"> <li>Coloured glass may obstruct the signal reception/transmission.</li> </ul>	10
The unit is on but cannot be operated.	<ul style="list-style-type: none"> <li>Do not place the signal sensor in direct sunlight or in areas that may be subject to sunlight exposure.</li> </ul>	10
	<ul style="list-style-type: none"> <li>The child lock function is activated.</li> </ul>	36
	<ul style="list-style-type: none"> <li>Some operations are prohibited by the disc.</li> </ul>	–
	<ul style="list-style-type: none"> <li>The unit is warm (“U59” appears on the unit’s display). Wait until “U59” disappears.</li> </ul>	64
	<ul style="list-style-type: none"> <li>One of the unit’s safety devices may have been activated.</li> </ul>	–
	Reset the unit as follows: (1) Press [⏻] on the main unit to switch to standby. If the unit does not switch to standby, press and hold [⏻] on the main unit for about 10 seconds. The unit is forcibly switched to standby. Alternatively, disconnect the AC mains lead, wait for about 1 minute, then reconnect it. (2) Press [⏻] on the main unit to turn the unit on.	–
	<ul style="list-style-type: none"> <li>The child lock function is activated.</li> </ul>	36
Cannot eject a disc.	<ul style="list-style-type: none"> <li>The unit is recording.</li> </ul>	–
	<ul style="list-style-type: none"> <li>The unit may have a problem. While the unit is off, hold down [■] and [CH, ▲] on the main unit simultaneously for about 5 seconds. Remove the disc and consult the dealer.</li> </ul>	–
	<ul style="list-style-type: none"> <li>The child lock function is activated.</li> </ul>	36
Cannot tune channels.	<ul style="list-style-type: none"> <li>Check the connections.</li> </ul>	12
Startup is slow.	<ul style="list-style-type: none"> <li>Make sure that “Quick Start” is set to “On”. Even if “Quick Start” is set to “On”, startup is slow if the clock is not set, there was a power failure or the AC plug has just been connected.</li> <li>A few dozen seconds after turning on the unit, you can play a disc or start recording to discs other than DVD-RAM.</li> <li>Startup takes time for a few minutes after 5:15 a.m. due to system maintenance of this unit.</li> </ul>	59
Takes time to read DVD-RAM.	<ul style="list-style-type: none"> <li>It may take time to read a disc if it is being used for the first time in this unit or it has not been used for a long time.</li> </ul>	–

Picture		Page
TV reception worsens after connecting the unit.	<ul style="list-style-type: none"> <li>This can occur because the signals are being divided between the unit and other equipment. It can be solved by using a signal booster, available from audio-visual suppliers.</li> </ul>	–
The images from the unit do not appear on the TV.	<ul style="list-style-type: none"> <li>Make sure that the TV is connected to the VIDEO OUT terminal, S VIDEO OUT terminal or COMPONENT VIDEO OUT terminals on the unit.</li> </ul>	12, 13
Picture is distorted.	<ul style="list-style-type: none"> <li>Make sure that the TV’s input setting (e.g., AV 1) is correct.</li> </ul>	–
	<ul style="list-style-type: none"> <li>The TV is not compatible with progressive signals. Press and hold [■] and [▶ DVD, COPYING] on the main unit at the same time for about 5 seconds. The setting will change to interlace.</li> </ul>	–
The TV screen is distorted when switching the DVD/VHS.	<ul style="list-style-type: none"> <li>The colour of the screen may turn to monochrome or the screen may be distorted depending on the TV used when you switch the DVD/VHS. However, this is not a malfunction.</li> </ul>	–
On-screen messages do not appear.	<ul style="list-style-type: none"> <li>Select “Automatic” in “On-Screen Messages” in the Setup menu.</li> </ul>	58
The grey background does not appear.	<ul style="list-style-type: none"> <li>Select “On” in “Grey Background” in the Setup menu.</li> </ul>	58
The 4:3 aspect ratio picture expands left and right.	<ul style="list-style-type: none"> <li>Use the TV to change the aspect. If your TV does not have that function, set “Progressive” in the Picture menu to “Off”.</li> </ul>	35
Screen size is wrong.	<ul style="list-style-type: none"> <li>Check the settings for “TV Aspect” in the Setup menu.</li> </ul>	59
There is a lot of after-image when playing video.	<ul style="list-style-type: none"> <li>Set “Copy NR” in the Picture menu to “Off”.</li> </ul>	35
When playing DVD-Video using progressive output, one part of the picture momentarily appears to be doubled up.	<ul style="list-style-type: none"> <li>Set “Progressive” in the Picture menu to “Off”. This problem is caused by the editing method or material used on DVD-Video, but should be corrected if you use interlace output.</li> </ul>	35
There is no apparent change in picture quality when adjusted with the Picture menu in the on-screen menus.	<ul style="list-style-type: none"> <li>The effect cannot be seen with certain types of video.</li> </ul>	–

Recording, Timer recording, Transfer (copying), External input	Page			
<b>Cannot record.</b>	<ul style="list-style-type: none"> <li>You have not inserted a disc or the disc you inserted cannot be recorded on. Insert a disc the unit can record onto.</li> <li><b>RAM -RW(V) +R +R DL +RW</b> The disc is unformatted. Format the disc.</li> <li>The write-protect tab on the cartridge is set to "PROTECT" or the disc is protected with "DVD Management".</li> <li>Some programmes have limitations on the number of times they can be recorded (CPRM).</li> <li>The disc is full or nearly full. Delete unneeded titles or use another disc.</li> <li>You cannot record on finalized DVD-R, DVD-R DL, DVD-RW (DVD-Video format), +R, +R DL or DVD-RW (DVD Video Recording format) discs.</li> <li>If you repeatedly insert discs or turn the unit on and off about 50 times or more, the recording or editing of DVD-R, DVD-R DL, DVD-RW (DVD-Video format), +R, +R DL, +RW may be disabled.</li> <li>A DVD-R, DVD-R DL, DVD-RW (DVD-Video format), +R, +R DL, +RW recorded on the unit may not be recordable on other Panasonic DVD recorders.</li> <li>The material you are trying to record is copy-protected.</li> <li>This unit cannot record to discs containing both PAL and NTSC signals.</li> </ul>	<p>6, 17</p> <p>55</p> <p>55</p> <p>6, 62</p> <p>27, 37, 53</p> <p>56</p> <p>–</p> <p>–</p> <p>–</p> <p>–</p>		
	<b>Timer recording does not work properly.</b>	<ul style="list-style-type: none"> <li>The timer programme is incorrect or different timer programme times overlap. Correct the programme.</li> <li>The clock is not correct. Set the clock.</li> <li>The programme is not in timer recording standby. (⏸ is not displayed by the programme you want to record.)</li> </ul>	<p>25</p> <p>61</p> <p>25</p>	
		<p><b>For Australia and New Zealand</b></p> <p><b>G-CODE programming does not work properly.</b></p>	<p>1 Press [PROG/CHECK].</p> <p>2 Press [▲, ▼] to select the programme and then press [A].</p> <p>–</p>	
		<ul style="list-style-type: none"> <li>Timer recording will not be activated during formatting, transfer (copying) and other such operations which should not be interrupted when they are being carried out.</li> </ul>	<p>–</p>	
	<b>Timer recording does not stop even when [■, STOP] is pressed.</b>	<ul style="list-style-type: none"> <li>If you start recording immediately after turning on the unit while "Quick Start" is set to "On", you cannot stop recording for a few seconds.</li> </ul>	<p>59</p>	
	<b>The timer programme remains even after recording finishes.</b>	<ul style="list-style-type: none"> <li>The timer programme remains if it is set to daily or weekly recording.</li> </ul>	<p>24</p>	
	<b>A part or whole of a recorded title has been lost.</b>	<ul style="list-style-type: none"> <li>If the power shuts down or the plug is disconnected from the household AC mains while recording or editing, the programme may be lost or the disc may become unusable. We cannot offer any guarantee regarding lost titles or discs. You will have to format the disc (<b>RAM -RW(V) +RW</b>) or use a new disc.</li> </ul>	<p>–</p>	
	<b>Cannot transfer (copy) VHS to DVD.</b>	<ul style="list-style-type: none"> <li>The write-protect tab on the cartridge is set to "PROTECT" or the disc is protected with "DVD Management".</li> <li>Some video cassettes on the market (including rental videos) are copy-protected to prevent illegal reproductions. Copy-protected video cassettes cannot be properly recorded.</li> <li>You cannot use the transfer (copying) function when the FUNCTIONS window, the Timer Recording List screen, etc. are displayed.</li> </ul>	<p>55</p> <p>–</p> <p>–</p>	
		<b>Cannot transfer (copy) DVD to VHS.</b>	<ul style="list-style-type: none"> <li>A video cassette without the accidental erasure prevention tab is inserted. Use a video cassette with an accidental erasure prevention tab.</li> <li>Some DVDs on the market (including rental DVD) are copy-protected to prevent illegal reproductions. Copy-protected DVDs cannot be properly recorded.</li> <li>You cannot use the transfer (copying) function when the FUNCTIONS window, the Timer Recording List screen, etc. are displayed.</li> </ul>	<p>17</p> <p>–</p> <p>–</p>
			<b>The sound level after transferring (copying) is not equal on DVD and on VHS.</b>	<ul style="list-style-type: none"> <li>The sound level on DVD and VHS may not match depending on the disc. When the sound level in a particular part of the sound source is soft or loud, the sound may be recorded softly or loudly on a video cassette.</li> </ul>
<b>Stripe-shaped black noise is recorded.</b>	<ul style="list-style-type: none"> <li>The device in playback is interfering with the TV because the device is too close to the TV. Move the device away from the TV.</li> </ul>	<p>–</p>		
<b>Cannot record video or sound from the external device.</b>	<ul style="list-style-type: none"> <li>The external device is not correctly connected.</li> <li>The proper external input channel (AV1, AV2 or DV IN) is not selected.</li> </ul>	<p>50</p> <p>50</p>		
	<b>The DV automatic recording function does not work.</b>	<ul style="list-style-type: none"> <li>If images cannot be recorded or if the recording is aborted, check the connections and DV equipment settings.</li> <li>You cannot start recording until the images from the DV equipment appear on the television.</li> <li>Recording may not be performed as desired if the time codes on the tape in the DV equipment are not successive.</li> <li>Depending on the equipment, the DV Auto Rec may not operate properly.</li> <li>You can only record audio/video images on the DV cassette.</li> </ul>	<p>50, 51</p> <p>–</p> <p>–</p> <p>51</p> <p>51</p>	



Play		Page
<b>Play fails to start even when [▶, PLAY] is pressed.</b> <b>Play starts but then stops immediately.</b>	● Insert the disc correctly with the label facing up.	17
	● The disc is dirty.	8
	● You tried to play a blank disc or a disc that is unplayable on the unit.	6, 7
	● You tried to play a +RW that needs to be finalized on the equipment used for recording.	–
	● When recording to DVD-RAM using “EP ( 8Hours )” mode, play may not be possible on DVD players that are compatible with DVD-RAM. In this case use “EP ( 6Hours )” mode.	58
<b>Audio and video momentarily pause.</b>	● This occurs between playlist chapters.	–
	● This occurs as scenes change during Quick View.	26
<b>DVD-Video is not played.</b>	● Some DVD-Video cannot be played when you change the ratings level.	57
<b>Alternative soundtrack and subtitles cannot be selected.</b>	● Multiple languages are not recorded on the disc.	–
	● You may have to use the disc’s own menus to select languages.	–
<b>No subtitles.</b>	● Subtitles are not recorded on the disc.	–
	● Set “Subtitle” in the Disc menu to “On”.	34
<b>Angle cannot be changed.</b>	● This function depends on software availability. Angles can only be changed during scenes where different angles are recorded.	–
<b>You have forgotten your ratings password.</b>	● With the tray open, press and hold [●, REC] and [▶] on the main unit simultaneously for about 5 seconds or more.	–
<b>Quick View does not work.</b>	● This does not work when audio is other than Dolby Digital.	–
	● This does not work when recording is in XP or FR mode.	–
<b>The resume play function does not work.</b>	● Memorized positions are cancelled when the unit is turned off or when the tray is opened. The memorized position on a playlist is also cancelled when the playlist or title is edited.	–
<b>The Video CD picture does not display properly.</b>	● When connecting to Multi-system TV, select “NTSC” in “TV System” in the Setup menu.	59
	● When connecting to PAL TV, the lower part of the picture cannot be displayed correctly during search.	–
<b>When playing a PAL disc, the picture is distorted.</b>	● Set “Transfer” in the Picture menu to “Auto”.	35
<b>When playing a DivX disc, the picture is distorted.</b>	● Change “Source select” in the Disc menu.	34
<b>It takes time before play starts.</b>	● This is normal for DivX video.	–
<b>Picture stops.</b>	● The picture may stop if the DivX files are greater than 2 GB.	–

Sound		Page
<b>No sound.</b> <b>Low volume.</b> <b>Distorted sound.</b> <b>Cannot hear the desired audio type.</b>	● Check the connections and “Digital Audio Output” settings. Check the input mode on the amplifier if you have connected one.	12, 13, 58
	● Press [AUDIO] to select the audio.	27, 33
	● Set “V.S.S.” in the Sound menu to “Off” in the following cases.	35
	- When using discs that do not have surround sound effects such as Karaoke discs.	–
	- When playing bilingual broadcast titles.	–
<b>Cannot switch audio.</b>	● <b>DVD-A</b> The disc may have a restriction on the method of audio output. Some multi-channel DVD-Audio discs prohibit down-mixing. If this is the case, this unit can only output the front two channels. Refer to the disc’s jacket.	–
	● Audio may not be output due to how the DivX files are created.	–
	● You cannot change the audio type when playing DVD-R, DVD-R DL, DVD-RW (DVD-Video format), +R, +R DL or +RW. (You can select “M 1” or “M 2” in “Bilingual Audio Selection” in the Setup menu before recording.)	58
	● You have used a digital connection. Set “Dolby Digital” to “PCM” or connect using audio cables (analogue connection).	13, 58
	● There are discs whose audio cannot be changed because of how the disc was created.	–

Edit		Page
Cannot format.	<ul style="list-style-type: none"> <li>•The disc is dirty. Wipe with a damp cloth and then wipe dry.</li> <li>•You tried formatting a disc that is not compatible with the unit.</li> </ul>	8 6
Cannot create chapters.	<ul style="list-style-type: none"> <li>•The unit writes the chapter division information to the disc when you turn it off or remove the disc. The information is not written if there is an interruption in the power before this.</li> </ul>	–
Cannot mark the start point or the end point during “Partial Delete” operation.	<ul style="list-style-type: none"> <li>•These operations are not possible with still pictures.</li> <li>•You cannot set points if they are too close to each other. You cannot set an end point before a start point.</li> </ul>	– –
Cannot delete chapters.	<ul style="list-style-type: none"> <li>•When the chapter is too short to delete, use “Combine Chapters” to make the chapter longer.</li> </ul>	39
The available recording time does not increase even after deleting recordings on the disc.	<ul style="list-style-type: none"> <li>•Available recording space on the DVD-R, the DVD-R DL, the +R or the +R DL does not increase even after deleting previously recorded titles.</li> <li>•Available recording space on a DVD-RW (DVD-Video format) or +RW increases only when the title recorded last is deleted. It does not increase if other titles are deleted.</li> </ul>	– –
Cannot create a playlist.	<ul style="list-style-type: none"> <li>•You cannot select all the chapters in a title at once as the source of playlist edition if the title also includes still pictures. Select them individually.</li> </ul>	–

VHS Picture		Page
OSD messages do not appear.	<ul style="list-style-type: none"> <li>•Go to Setup and select “Automatic” in “On-Screen Messages”. Press [STATUS] to show the on-screen messages constantly.</li> </ul>	33, 58
The gray background appears during play.	<ul style="list-style-type: none"> <li>•You are playing a blank or poor quality part of the video cassette.</li> <li>•You can damage the unit if you play dirty or damaged video cassettes and this can cause the gray background to appear. Consult your dealer.</li> </ul>	– –

VHS Sound		Page
Cannot hear the desired audio type.	<ul style="list-style-type: none"> <li>•Press [AUDIO] to select the audio.</li> </ul>	33
There is noise when playing a video cassette.	<ul style="list-style-type: none"> <li>•Adjust the tracking.</li> <li>•The tape is old or damaged.</li> </ul>	33 –

VHS Recording, Timer Recording		Page
“  ” flashes when I try to start recording.	<ul style="list-style-type: none"> <li>•A video cassette is not inserted. Insert a video cassette with an intact accidental erasure prevention tab.</li> </ul>	17
Cannot record.	<ul style="list-style-type: none"> <li>•The erasure prevention tab has been removed. Cover the hole with adhesive tape.</li> </ul>	17
Cannot record TV programme.	<ul style="list-style-type: none"> <li>•The desired channel is not selected. Select the desired TV programme.</li> </ul>	–

VHS Play		Page
Playback does not work properly.	<ul style="list-style-type: none"> <li>•The video head is dirty.</li> <li>•The tape is too old or damaged.</li> <li>•Check the “SQPB” setting.</li> <li>•The video heads are clogged or worn: consult your dealer (for Australia only, Panasonic Customer Care Centre for advice on 132600).</li> </ul>	17 – 59 –

# Specifications

## Power supply:

**For Asia and the Middle East**  
AC 220 V to 240 V, 50/60 Hz  
**For Australia and New Zealand**  
AC 220 V to 240 V, 50 Hz

## Power consumption:

Approx. 26 W

### Standby mode:

		Display On	Display Off
Quick Start On	Approx.	7.0 W	6.8 W
Quick Start Off	Approx.	2.6 W	2.5 W

## Recordable discs:

DVD-RAM:	Ver. 2.0 Ver. 2.1/3X-SPEED DVD-RAM Revision 1.0 Ver. 2.2/5X-SPEED DVD-RAM Revision 2.0
DVD-R:	Ver. 2.0 for General Ver. 2.0/4X-SPEED DVD-R Revision 1.0 for General Ver. 2.x/8X-SPEED DVD-R Revision 3.0 for General Ver. 2.x/16X-SPEED DVD-R Revision 6.0 for DL Ver. 3.0 for DL Ver. 3.x/4X-SPEED DVD-R for DL Revision 1.0
DVD-RW:	Ver. 1.1 Ver. 1.1/2X-SPEED DVD-RW Revision 1.0 Ver. 1.2/4X-SPEED DVD-RW Revision 2.0
+R:	Ver. 1.0/2.4X-SPEED Ver. 1.1/4X-SPEED Ver. 1.2/8X-SPEED Ver. 1.3/16X-SPEED for DL Ver. 1.0/4X-SPEED
+RW:	Ver. 1.1 Ver. 1.2/4X-SPEED

## Recording system:

DVD-RAM:	DVD Video Recording format
DVD-R:	DVD-Video format
DVD-R DL (Dual Layer):	DVD-Video format
DVD-RW:	DVD-Video format
+R	
+R DL (Double Layer)	
+RW	

## Recording time:

Max. 8 hours (using 4.7 GB disc)	
XP: Approx. 1 hour	SP: Approx. 2 hours
LP: Approx. 4 hours	EP: Approx. 6 hours or 8 hours

## Playable discs:

DVD-RAM:	DVD Video Recording format
DVD-R:	DVD-Video format, DivX
DVD-R DL (Dual Layer):	DVD-Video format
DVD-RW:	DVD-Video format, DVD Video Recording format
+R	
+R DL (Double Layer)	
+RW	
DVD-Video, DVD-Audio	
CD-Audio (CD-DA), Video CD	
CD-R/CD-RW (CD-DA, Video CD, DivX, MP3, JPEG)	

## Optical pick-up:

System with 1 lens, 2 integration units  
(662 nm wavelength for DVDs, 780 nm wavelength for CDs)

## LASER specification:

Class 1 LASER Product	
Wave Length:	780 nm (CDs) 662 nm (DVDs)
Laser Power:	No hazardous radiation is emitted with the safety protection

## Television system:

**TV system:** PAL system, 625 lines, 50 fields  
NTSC system, 525 lines, 60 fields

## Antenna reception input:

<b>For Asia and the Middle East</b>	
VHF:	CH R1 to R12 (PAL-DK, SECAM-DKK1) E2 to E12 (PAL-BGH, SECAM-BG) CH 1 to 12 (PAL-D) 75 Ω
UHF:	CH 21 to 69 (PAL-DK, SECAM-DKK1) E21 to E69 (PAL-BGH, SECAM-BG, PAL-I) CH 13 to 57 (PAL-D) 75 Ω
CATV:	CH 44 MHz to 470 MHz (PAL-DK, SECAM-DKK1) CH S01 to S05, M1 to M10, U1 to U10, S21 to S41 (PAL-BGH, SECAM-BG) (PAL-D) 75 Ω
<b>For Australia and New Zealand</b>	
VHF:	CH 0 to 12 (Australia), CH 1 to 11 (NZ), 75 Ω
UHF:	CH 28 to 69 (Australia), CH 21 to 69 (NZ), 75 Ω
CATV:	45 MHz to 470 MHz (Australia), 44 MHz to 470 MHz (NZ), 75 Ω

## Video system:

### Recording system: (for DVD)

MPEG2 (Hybrid VBR)	
<b>Input:</b>	LINE (pin jack)×2 S connector×2
	Y: 1.0 Vp-p; 75 Ω C: 0.286 Vp-p; 75 Ω
<b>Output:</b>	LINE (pin jack)×2 S connector×1
(for DVD PRIORITY)	Y: 1.0 Vp-p; 75 Ω C: 0.286 Vp-p; 75 Ω
<b>Component video output:</b>	Y, Pb, Pr ×1
(for DVD PRIORITY)	(480i/480p) NTSC (576i/576p) PAL
	Y: 1.0 Vp-p; 75 Ω Pb: 0.7 Vp-p; 75 Ω Pr: 0.7 Vp-p; 75 Ω

## Audio system:

### Recording system: (for DVD)

Dolby Digital (2 ch)	
<b>Analogue input:</b>	LINE (pin jack)×2
	Reference input: 309 mVrms FS: 2 Vrms (1 kHz, 0 dB) Input impedance: 22 kΩ
<b>Analogue output:</b>	LINE (pin jack)×2
	Reference output: 309 mVrms FS: 2 Vrms (1 kHz, 0 dB) Output impedance: 1 kΩ (Load impedance: 10 kΩ)

### Number of channels: (for DVD)

Recording: 2 channels  
Playback: 2 channels

### Number of track: (for VHS)

Hi-Fi: 2 track  
Normal: 1 track

### Digital Output:

(for DVD PRIORITY) Digital audio optical output connector×1  
(PCM, Dolby Digital, DTS)

## VHS

<b>Recording format:</b>	VHS Video Cassette System Standard with FM audio
<b>Heads:</b>	4 Helical Scan Heads for Video 2 Helical Scan Heads for FM audio 1 Fixed Head for Normal audio

### Tape speed/Recording time:

SP: 23.39 mm/s, 240 min (with E-240 cassette)  
LP: 11.7 mm/s, 480 min (with E-240 cassette)  
EP: 7.8 mm/s, 720 min (with E-240 cassette)  
FF/REW: Approx. 60 s (with E-180 cassette)  
Jet RW: Approx. 50 s (with E-180 cassette)

### FF/REW time:

## Specifications

<b>DV Input:</b>	IEEE 1394 Standard, 4 Pin×1
<b>Region code</b>	<b>For Asia</b> 3 <b>For Australia and New Zealand</b> 4 <b>For the Middle East</b> 2
<b>Clock unit:</b>	Quartz-controlled 24-hour digital display
<b>Operating temperature range:</b>	5 °C to 40 °C
<b>Operating humidity range:</b>	10% to 80% RH (no condensation)
<b>Dimensions:</b>	Approx. 430 mm (W)×84 mm (H)×343 mm (D)
<b>Mass:</b>	Approx. 5.4 kg
<b>DVD (DivX), CD (DivX):</b>	DivX 3.11, 4.x, 5.x GMC (Global Motion Compensation) is not supported.

**DVD (DivX), CD (DivX):** Common items  
**Maximum number of folders:**  
300 Recognizable folders per disc on this unit  
(including the root folder)  
**Maximum number of DivX files:**  
200 Recognizable DivX files per disc on this unit\*1

**CD (MP3):**  
**Format:** ISO9660 level 1 or 2 (except for extended formats), Joliet  
**Compatible compression rate:**  
32 kbps to 320 kbps  
**Compatible sampling rate:**  
16 kHz, 22.05 kHz, 24 kHz, 32 kHz, 44.1 kHz, 48 kHz  
**This unit is not compatible with ID3 tags.**

**CD (JPEG):**  
**Format:** ISO9660 level 1 or 2 (except for extended formats), Joliet  
**Compatible pixels:**  
Between 34 × 34 and 6144 × 4096 pixels  
Sub Sampling 4:2:2 or 4:2:0  
**This unit is not compatible with Motion JPEG.**

**CD (MP3), CD (JPEG):** Common items  
**Maximum number of folders:**  
300 Recognizable folders per disc on this unit  
(including the root folder)  
**Maximum number of MP3 files:**  
3000 Recognizable MP3 files per disc on this unit\*1  
**Maximum number of JPEG files:**  
3000 Recognizable JPEG files per disc on this unit\*1  
**This unit is compatible with multi-session.**  
**This unit is not compatible with packet writing.**

\*1 Total number of recognizable files including MP3, JPEG, DivX and other type of files is 4000.

### Quick Start for Recording (Quick Start: ON)

1 Sec. Quick Start for Recording on DVD-RAM\*2

\*2 From the power off state, recording on DVD-RAM starts about 1 second after first pressing the Power button and then sequentially pressing the REC button (Quick Start Mode).

---

### Note

Specifications are subject to change without notice.  
Mass and dimensions shown are approximate.

Angle .....	34
Audio	
attributes .....	34
language .....	34
playback .....	27, 33
Auto Setup .....	14
Change Thumbnail .....	38, 42
Channel	
audio .....	34
settings .....	14, 60
Chapter .....	27, 39
Chasing playback .....	21
Child Lock .....	36
Cleaning	
disc .....	8
lens .....	8
main unit .....	8
video heads .....	17
Clock setting .....	14, 61
Close First Layer .....	56
Connection	
amplifier, system component .....	13
antenna, television .....	12
DV IN terminal .....	50, 51
external device .....	50
video cassette recorder .....	12, 50
Copy .....	44
Copy (playlist) .....	42
Copy NR .....	35
<b>For Australia and New Zealand</b>	
Country setting .....	14
CPRM .....	62
Create chapter .....	27, 39, 43
Create playlists .....	40
Create Top Menu .....	55
Default Settings .....	59
Delete	
all titles .....	55
chapter .....	39, 43
chapter in playlist .....	43
playlist .....	41
title .....	27, 37, 53
Delete Navigator .....	53
Dialog Enhancer .....	35
Direct Navigator .....	37
Display menus .....	34
Divide Title .....	39
DivX .....	28, 29, 31, 62
DV Automatic Recording .....	51
DVD-RAM, DVD-R, DVD-R DL, DVD-RW, +R, +R DL, +RW .....	6
Enter Name	
disc .....	54
entering text .....	52
playlist .....	42
title .....	23, 24, 38
Finalize .....	56, 62
Flexible Recording .....	22
Format disc .....	55
FR (Flexible Recording) Mode .....	19, 22
FUNCTIONS window .....	36
<b>For Australia and New Zealand</b> G-CODE .....	23
Jet Rewind .....	32
JPEG .....	28, 30, 31, 62
Language	
code list .....	59
soundtrack .....	34, 57
subtitle .....	34, 57
Manual Skip .....	26
Menu	
DivX .....	28
JPEG .....	30
MP3 .....	29
on-screen .....	34
Setup .....	57
Modes	
recording .....	19, 25
still mode .....	58
MP3 .....	28, 29, 31
Noise reduction (NR)	
Copy NR .....	35
Playback NR .....	35
One Touch Transfer .....	44, 45, 47
On-screen	
menus .....	34
status messages .....	36
On-screen display .....	33
Partial Delete .....	38
PCM Down Conversion .....	58
Picture settings .....	58
Playback NR .....	35
Playlists .....	40
Power Save .....	59
Progressive .....	13, 16, 35, 59, 62
Properties	
playlist .....	41
still pictures .....	30
title .....	37
Protection	
cartridge .....	55
disc .....	55
title .....	38
Quick Start .....	12, 59
Quick View .....	26
Ratings .....	57
Recording	
DV automatic recording .....	51
Flexible Recording .....	22
mode .....	19, 25
timer .....	23
Recording modes .....	19
Remote Control Code .....	15
Repeat play .....	35
Repeat Playback .....	32
Resetting channel settings .....	60
Resume play function .....	26
Setup menu .....	57
Shipping Conditions .....	59
Shorten (titles) .....	38
Simultaneous recording and play .....	21
Soundtrack .....	27, 34, 57
Source Select	
DivX .....	34
SQPB .....	32
Status displays .....	36
Status messages .....	36
Subtitle .....	34, 57
Time Slip .....	27
Thumbnail .....	38, 42
TIFF .....	28, 30, 31, 62
Time Slip .....	27
Timer recording .....	23
Tracking .....	33
Transfer .....	35
Tuning	
automatic .....	14, 61
manual .....	60
TV aspect .....	14, 15
TV System (PAL/NTSC) .....	59
TV Type .....	15
V.S.S. .....	35
VISS .....	33







Official DivX Certified™ product.

Plays DivX®5, DivX®4, DivX®3, DivX® VOD video content (in compliance with DivX Certified™ technical requirements).  
DivX, DivX Certified, and associated logos are trademarks of DivXNetworks, Inc. and are used under license.

---

Manufactured under license from Dolby Laboratories.

“Dolby” and the double-D symbol are trademarks of Dolby Laboratories.

---

“DTS” and “DTS 2.0+ Digital Out” are trademarks of Digital Theater Systems, Inc.

---

This product incorporates copyright protection technology that is protected by method claims of certain U.S. patents and other intellectual property rights owned by Macrovision Corporation and other rights owners. Use of this copyright protection technology must be authorized by Macrovision Corporation, and is intended for home and other limited viewing uses only unless otherwise authorized by Macrovision Corporation. Reverse engineering or disassembly is prohibited.

---

G-CODE is a registered trademark of Gemstar Development Corporation. The G-CODE system is manufactured under license from Gemstar Development Corporation.